

Pallet truck scale KERN VHB

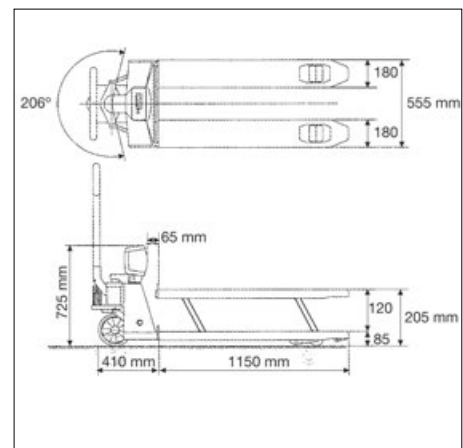

Pallet truck scale with complete protection against dust and water splashes IP65/67 and a memory for a container weight

**Features**

- PRE-TARE function for manual subtraction of a known container weight, useful for checking fill-levels
- **1** Display device: plastic, protection against dust and water splashes IP65
- **2** Load fork: Protection against dust and water splashes IP67, temporary use in wet areas possible
- Pivot range 206°
- Castors: Solid rubber on aluminium rims
- **3** Load rollers: Tandem tyres to overcome thresholds and obstacles more easily
- Totalising of weights
- Ready for use: Batteries included, 4×1.5 V AA, operating time up to 80 h

**Technical data**

- Large LCD display, digit height 28 mm
- Permissible ambient temperature -10 °C/40 °C

**Accessories**

- Castors made of red polyurethane on aluminium rims. Ideal for light-coloured flooring as they leave less visible abrasive marks. Suitable for the current models of the pallet truck scale range KERN VHB (when retrofitting, please give the serial number of the pallet truck scale available when ordering), scope of delivery: 1 item, KERN VHB-A02

**!** Shipment via freight forwarder. Please ask for dimensions, gross weight, shipping

STANDARD

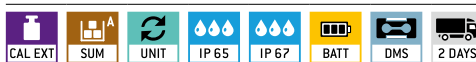

































OPTION



**1** **2**

Model	Weighing capacity [Max] kg	Readability [d] kg	Net weight approx. kg	Option	
				DAkkS KERN	DAkkS Calibr. Certificate
VHB 2T1	2000	1	110	963-131	

## Pictograms

 <b>Internal adjusting:</b> Quick setting up of the balance's accuracy with internal adjusting weight (motordriven)	 <b>KERN Communication Protocol (KCP):</b> It is a standardized interface command set for KERN balances and other instruments, which allows retrieving and controlling all relevant parameters and functions of the device. KERN devices featuring KCP are thus easily integrated with computers, industrial controllers and other digital systems	 <b>Suspended weighing:</b> Load support with hook on the underside of the balance
 <b>Adjusting program CAL:</b> For quick setting up of the balance's accuracy. External adjusting weight required	 <b>GLP/ISO log:</b> The balance displays serial number, user ID, weight, date and time, regardless of a printer connection	 <b>Battery operation:</b> Ready for battery operation. The battery type is specified for each device
 <b>Easy Touch:</b> Suitable for the connection, data transmission and control through PC or tablet.	 <b>GLP/ISO log:</b> With weight, date and time. Only with KERN printers.	 <b>Rechargeable battery pack:</b> Rechargeable set
 <b>Memory:</b> Balance memory capacity, e.g. for article data, weighing data, tare weights, PLU etc.	 <b>Piece counting:</b> Reference quantities selectable. Display can be switched from piece to weight	 <b>Universal plug-in power supply:</b> with universal input and optional input socket adapters for A) EU, CH, GB; B) EU, CH, GB, USA; C) EU, CH, GB, USA, AUS
 <b>Alibi memory:</b> Secure, electronic archiving of weighing results, complying with the 2014/31/EU standard.	 <b>Recipe level A:</b> The weights of the recipe ingredients can be added together and the total weight of the recipe can be printed out	 <b>Plug-in power supply:</b> 230V/50Hz in standard version for EU, CH. On request GB, USA or AUS version available
 <b>Data interface RS-232:</b> To connect the balance to a printer, PC or network	 <b>Recipe level B:</b> Internal memory for complete recipes with name and target value of the recipe ingredients. User guidance through display	 <b>Integrated power supply unit:</b> Integrated in balance. 230V/50Hz standard EU. More standards e.g. GB, USA or AUS on request
 <b>RS-485 data interface:</b> To connect the balance to a printer, PC or other peripherals. Suitable for datatransfer over large distances. Network in bus topology is possible	 <b>Totalising level A:</b> The weights of similar items can be added together and the total can be printed out	 <b>Weighing principle: Strain gauges:</b> Electrical resistor on an elastic deforming body
 <b>USB data interface:</b> To connect the balance to a printer, PC or other peripherals	 <b>Percentage determination:</b> Determining the deviation in % from the target value (100 %)	 <b>Weighing principle: Tuning fork:</b> A resonating body is electromagnetically excited, causing it to oscillate
 <b>Bluetooth* data interface:</b> To transfer data from the balance to a printer, PC or other peripherals	 <b>Weighing units:</b> Can be switched to e.g. nonmetric units. See balance model. Please refer to KERN's website for more details	 <b>Weighing principle: Electromagnetic force compensation:</b> Coil inside a permanent magnet. For the most accurate weighings
 <b>WiFi data interface:</b> To transfer data from the balance to a printer, PC or other peripherals	 <b>Weighing with tolerance range:</b> (Checkweighing) Upper and lower limiting can be programmed individually, e.g. for sorting and dosing. The process is supported by an audible or visual signal, see the relevant model	 <b>Weighing principle: Single cell technology:</b> Advanced version of the force compensation principle with the highest level of precision
 <b>Control outputs (optocoupler, digital I/O):</b> To connect relays, signal lamps, valves, etc.	 <b>Hold function:</b> (Animal weighing program) When the weighing conditions are unstable, a stable weight is calculated as an average value	 <b>Verification possible:</b> The time required for verification is specified in the pictogram
 <b>Analogue interface:</b> to connect a suitable peripheral device for analogue processing of the measurements	 <b>Protection against dust and water splashes IPxx:</b> The type of protection is shown in the pictogram.	 <b>DAKkS calibration possible (DKD):</b> The time required for DAKkS calibration is shown in days in the pictogram
 <b>Interface for second balance:</b> For direct connection of a second balance		 <b>Factory calibration (ISO):</b> The time required for Factory calibration is shown in days in the pictogram
 <b>Network interface:</b> For connecting the scale to an Ethernet network		 <b>Package shipment:</b> The time required for internal shipping preparations is shown in days in the pictogram
		 <b>Pallet shipment:</b> The time required for internal shipping preparations is shown in days in the pictogram

\*The Bluetooth® word mark and logos are registered trademarks owned by Bluetooth SIG, Inc. and any use of such marks by KERN & SOHN GmbH is under license. Other trademarks and trade names are those of their respective owners.

## KERN – Precision is our business

To ensure the high precision of your balance KERN offers you the the appropriate test weight in the international OIML error limit classes E1-M3 from 1 mg - 2500 kg. In combination with a DAKkS calibration certificate the best pre-requisite for proper balance calibration.

The KERN DAKkS calibration laboratory today is one of the most modern and best-equipped DAKkS calibration laboratories for balances, test weights and force-measurement in Europe.

Thanks to the high level of automation, we can carry out DAKkS calibration of balances, test weights and force-measuring devices 24 hours a day, 7 days a week.

### Range of services:

- DAKkS calibration of balances with a maximum load of up to 50 t
- DAKkS calibration of weights in the range of 1 mg - 2500 kg
- Volume determination and measuring of magnetic susceptibility (magnetic characteristics) for test weights
- Database supported management of checking equipment and reminder service
- Calibration of force-measuring devices
- DAKkS calibration certificates in the following languages DE, EN, FR, IT, ES, NL, PL
- Conformity evaluation and reverification of balances and test weights

## Your KERN specialist dealer: