

Internal Measurement

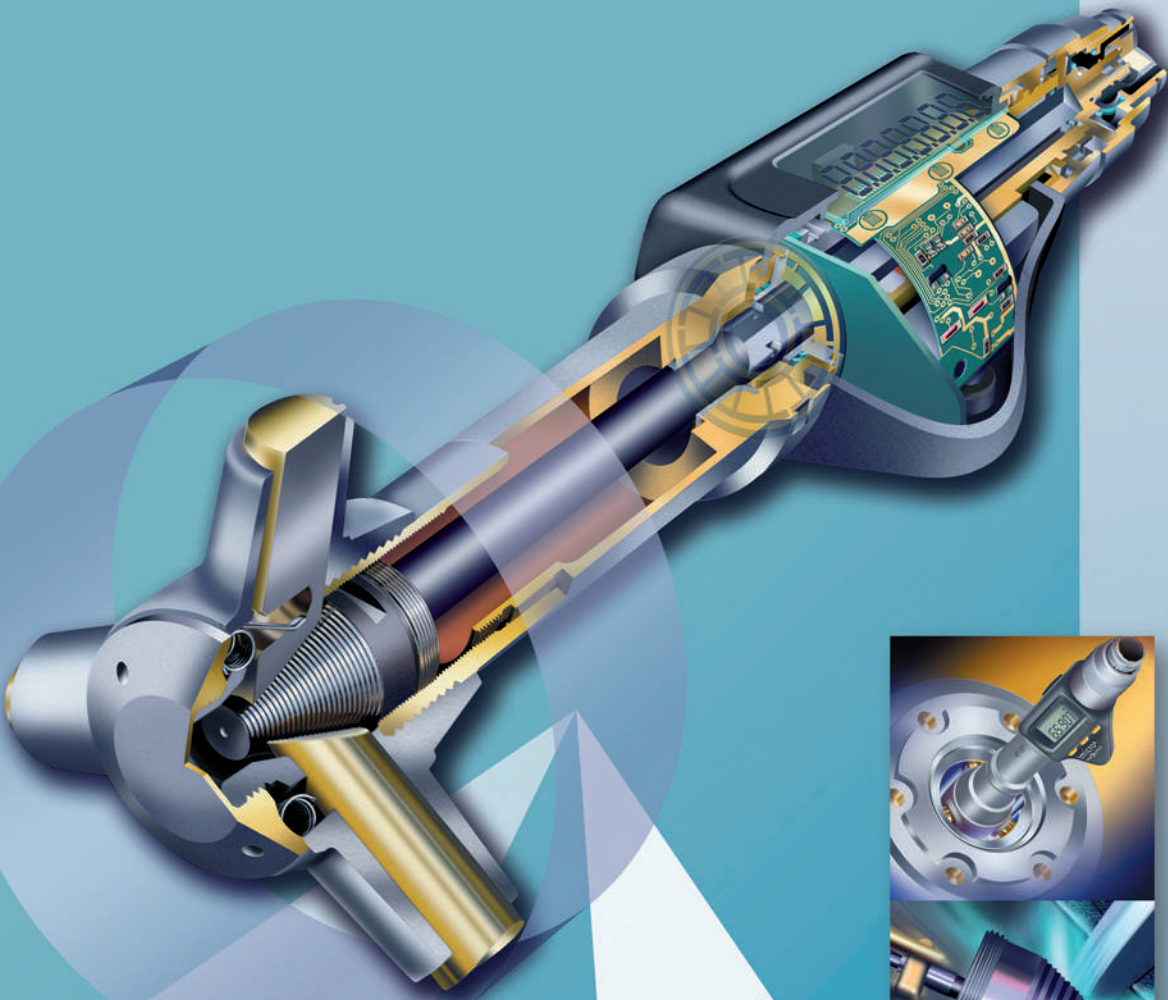

THE CHALLENGES OF INTERNAL MEASUREMENT

Bore measurement is more difficult than external measurement of components. Apart from the very tight tolerances specified, all measuring elements having a direct influence on the uncertainty of measurement must be designed in such a way that they can fit into the bore to be checked.

3-LINE CONTACT OFFERS A TRUE ADVANTAGE

The near perfect auto-centering and auto alignment provided by TESA IMICRO, TESA TRI-O-BOR, ALESOMETER and ETALON INTALOMETER make bore measurement reliable, without the need for an operator to estimate.

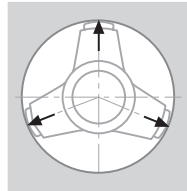

The three measuring bolts are spaced 120° apart, thus providing optimum self-centring.

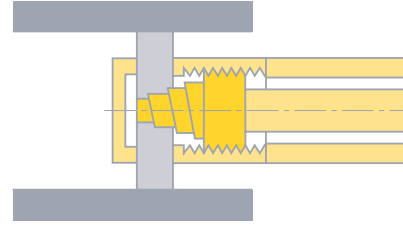

The measuring bolts with 3-line contact allows the micro-meter to align itself parallel to the contact surfaces.

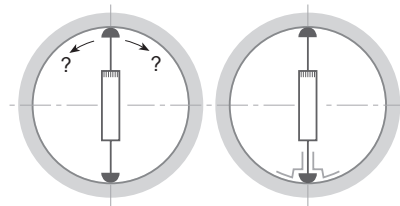

2-point contact measuring instruments are not self-centring. To enable bore measurements, the use of auxiliary means are required.

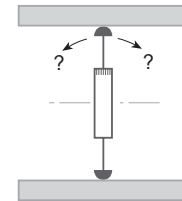

2-point contact does not permit the tool to align itself in relation to the bore axis.

A SINGLE TOOL CAN REPLACE HUNDREDS OF PLUG GAUGES

Unlike plug gauges that check only one toleranced size, a single tool can measure many diameters. Depending on the model that is being used, through holes and blind bores along with short centring shoulders can be inspected reliably.



ESTABLISHING FORM ERRORS

Form errors are established through measurements taken at several points within a bore. Micrometers with 3-line contact determine run-out errors in a triangular way. Micrometers with 2-point contact measure medium-size diameters only. They do not allow users to see what makes diameters measured at various points different.

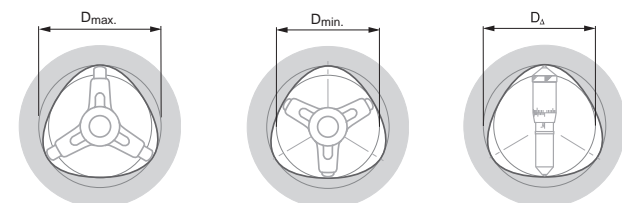
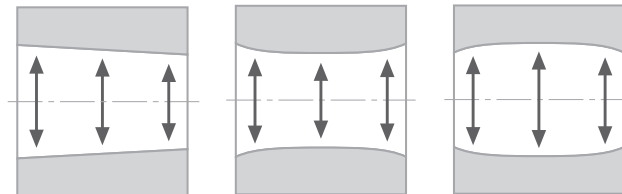

TESA IMICRO with Analogue Indication – Metric

Self-centring and self-aligning internal micrometers. The high-precision thread machined into the measuring cone, combined with the measuring bolts specially arranged to provide 3-line contact, make them the only micrometers in the world that respect the ABBE principle. Measure depth, reliably.

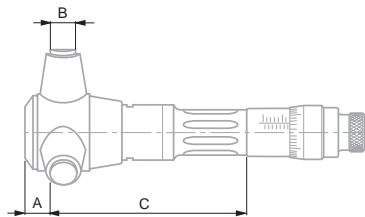
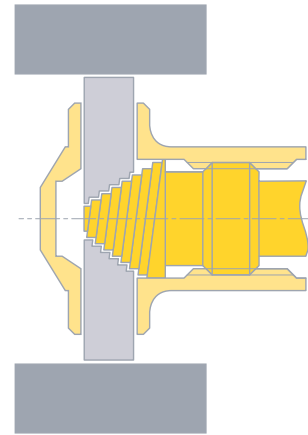
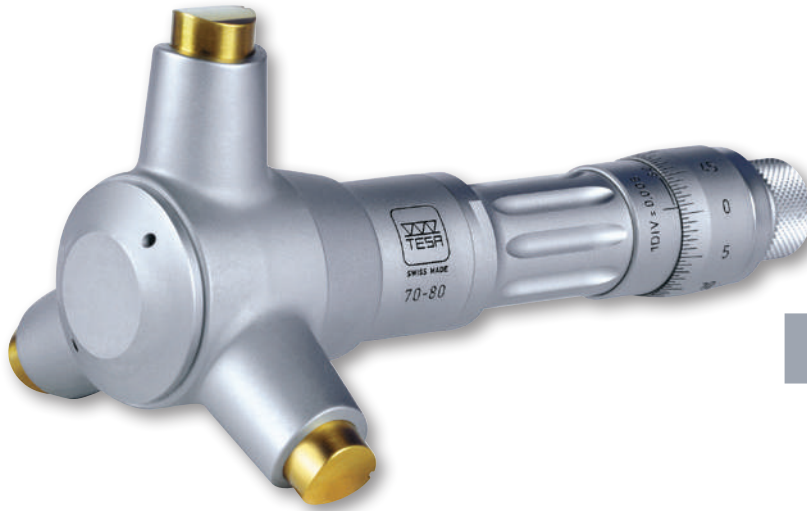

DIN 863 T4
(Style C1)
NFE 11-099



Measuring faces for application ranges from 3,5 to 12 mm:
hardened steel (HV30 770)
11 to 100 mm: TiN hard-coating (HV5 2300)
100 to 300 mm: carbide tipped (HV5 1300)









Application ranges from 3,5 to 200 mm in a shipping box
200 to 300 mm in a wooden case with 1 extension of 150 mm (No. 00842600)



Inspection report with a declaration of conformity



Identification number

No							
	mm	mm	µm	µm	A mm	B mm	C mm
00813410	3,5 ÷ 4	0,001	4	4	2	1,5	20
00813411	4 ÷ 4,5	0,001	4	4	2	1,5	20
00813412	4,5 ÷ 5,5	0,001	4	4	2	1,5	25
00813413	5,5 ÷ 6,5	0,001	4	4	2	1,5	25
00810001	6 ÷ 8	0,001	4	4	2,5	2,5	52
00810002	8 ÷ 10	0,001	4	4	2,5	2,5	52
00810003	10 ÷ 12	0,001	4	4	2,5	2,5	52
00810801	11 ÷ 14	0,005	4	4	3,5	4	77
00810802	14 ÷ 17	0,005	4	4	3,5	4	77
00810803	17 ÷ 20	0,005	4	4	3,5	4	77
00811501	20 ÷ 25	0,005	4	4	7	7	78
00811502	25 ÷ 30	0,005	4	4	7	7	78
00811503	30 ÷ 35	0,005	4	4	7	7	78
00811504	35 ÷ 40	0,005	4	4	7	7	78
00812301	40 ÷ 50	0,005	4	4	11	12	84
00812302	50 ÷ 60	0,005	5	5	11	12	84
00812303	60 ÷ 70	0,005	5	5	11	12	84
00812304	70 ÷ 80	0,005	5	5	11	12	84
00812305	80 ÷ 90	0,005	5	5	11	12	84
00812306	90 ÷ 100	0,005	5	5	11	12	84
00812601	100 ÷ 125	0,01	6	6	26	18	81
00812602	125 ÷ 150	0,01	6	6	26	18	81
00812603	150 ÷ 175	0,01	7	7	26	18	81
00812604	175 ÷ 200	0,01	7	7	26	18	81
00813101	200 ÷ 225	0,01	8	8	26	18	81
00813102	225 ÷ 250	0,01	8	8	26	18	81
00813103	250 ÷ 275	0,01	8	8	26	18	81
00813104	275 ÷ 300	0,01	8	8	26	18	81



TESA IMICRO with Analogue Indication – Full Metric Sets



DIN 863 T4
(Style C1)
NFE 11-099



Measuring faces
on models from
3,5 to 12 mm:
hardened steel,
HV30 770;
11 to 100 mm: tita-
nium nitride (TiN)
hard-coating
to HV5 2300.
100 to 200 mm:
tungsten carbide
tipped to HV5 1300.



Plastic case
or suitcase



Inspection report
with a declaration
of conformity



Identification
number



mm



Isolated
instruments



mm



Setting
rings



mm



Extensions



A mm

COMPOSITION OF THE SETS:

00813409	BAE	3,5 ÷ 6,5	00813410	3,5 ÷ 4	00843200	4		
			00813411	4 ÷ 4,5	00843201	5,5		
			00813412	4,5 ÷ 5,5				
			00813413	5,5 ÷ 6,5				
00810000	BAF	6 ÷ 12	00810001	6 ÷ 8	00840101	8	00840001	100
			00810002	8 ÷ 10	00840102	10		
			00810003	10 ÷ 12				
00810800	BAG	11 ÷ 20	00810801	11 ÷ 14	00840103	11	00840301	150
			00810802	14 ÷ 17	00840105	17		
			00810803	17 ÷ 20				
00811500	BAH	20 ÷ 40	00811501	20 ÷ 25	00840106	25	00841100	150
			00811502	25 ÷ 30	00840107	35		
			00811503	30 ÷ 35				
			00811504	35 ÷ 40				
00812300	BAJ	40 ÷ 100	00812301	40 ÷ 50	00840108	50	00841800	150
			00812302	50 ÷ 60	00840109	70		
			00812303	60 ÷ 70	00840110	90		
			00812304	70 ÷ 80				
			00812305	80 ÷ 90				
			00812306	90 ÷ 100				
00812600	BAK	100 ÷ 200	00812601	100 ÷ 125	00840112	125	00842600	150
			00812602	125 ÷ 150	00840113	175		
			00812603	150 ÷ 175				
			00812604	175 ÷ 200				

TESA IMICRO CAPA μ SYSTEM with Digital Display

A successful combination of the patented TESA capacitive system with the IMICRO unique cone.

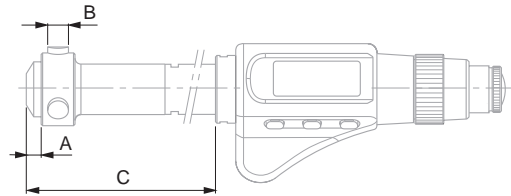

DIN 863 T4
(Style C1)



0,001 mm
0,00005 in



LCD, 7 mm
digit height



Floating zero



Metric/inch
Conversion



Measuring faces
for application
ranges 3,5 to 12 mm:
hardened steel
(770 HV 30)
11 to 100 mm:
TiN hard-coating
(2300 HV 5)
100 to 300 mm:
carbide tipped
(1300 HV 5)



3 V lithium battery



1 to 2 a
(\approx 2000 h/a)



Automatic shut
down after 10 min.
Display setting is
retained as long as
power supply
remains stable.



-10°C to 60°C



10°C to 40°C



80 %, non
condensing



Measuring
element IP54
(IEC 60529) or
IP40 with active
data output



Plastic case



TESA's
calibration
certificate



Declaration
of conformity



Identification
number



Display lock



RS232
opto-coupled,
bidirectional

No	mm	in	μ m	μ m	A mm	B mm	C mm
06130101	3,5 ÷ 4	0.1377 ÷ 0.1574	4	4	2	1,5	20
06130102	4 ÷ 4,5	0.1574 ÷ 0.1771	4	4	2	1,5	20
06130103	4,5 ÷ 5,5	0.1771 ÷ 0.2165	4	4	2	1,5	25
06130104	5,5 ÷ 6,5	0.2165 ÷ 0.2559	4	4	2	1,5	25
06130105	6 ÷ 8	0.2362 ÷ 0.3150	4	4	2,5	2,5	79
06130106	8 ÷ 10	0.3150 ÷ 0.3970	4	4	2,5	2,5	79
06130107	10 ÷ 12	0.3970 ÷ 0.4724	4	4	2,5	2,5	79
06130108	11 ÷ 14	0.4330 ÷ 0.5512	4	4	3,5	4	93
06130109	14 ÷ 17	0.5512 ÷ 0.6693	4	4	3,5	4	93
06130110	17 ÷ 20	0.6693 ÷ 0.7874	4	4	3,5	4	93
06130111	20 ÷ 25	0.7874 ÷ 0.9843	4	4	7	7	91
06130112	25 ÷ 30	0.9843 ÷ 1.1811	4	4	7	7	91
06130113	30 ÷ 35	1.1811 ÷ 1.3780	4	4	7	7	91
06130114	35 ÷ 40	1.3780 ÷ 1.5748	4	4	7	7	91
06130115	40 ÷ 50	1.5748 ÷ 1.9685	4	4	11	12	104
06130116	50 ÷ 60	1.9685 ÷ 2.3622	5	5	11	12	104
06130117	60 ÷ 70	2.3622 ÷ 2.7560	5	5	11	12	104
06130118	70 ÷ 80	2.7560 ÷ 3.1496	5	5	11	12	104
06130119	80 ÷ 90	3.1496 ÷ 3.5433	5	5	11	12	104
06130120	90 ÷ 100	3.5433 ÷ 3.9370	5	5	11	12	104
06130121	100 ÷ 125	3.9370 ÷ 4.9212	6	6	26	18	100
06130122	125 ÷ 150	4.9212 ÷ 5.9055	6	6	26	18	100
06130123	150 ÷ 175	5.9055 ÷ 6.8897	7	7	26	18	100
06130124	175 ÷ 200	6.8897 ÷ 7.8740	7	7	26	18	100
06130125	200 ÷ 225	7.8740 ÷ 8.8582	8	8	26	18	100
06130126	225 ÷ 250	8.8582 ÷ 9.8425	8	8	26	18	100
06130127	250 ÷ 275	9.8425 ÷ 10.8267	8	8	26	18	100
06130128	275 ÷ 300	10.8267 ÷ 11.8110	8	8	26	18	100

OPTIONAL ACCESSORY

01961000 1 Lithium battery 3V, CR2032



TESA IMICRO CAPA μ SYSTEM with Digital Display – Full Sets

A successful combination of the TESA patented capacitive measuring system with the IMICRO unique cone.

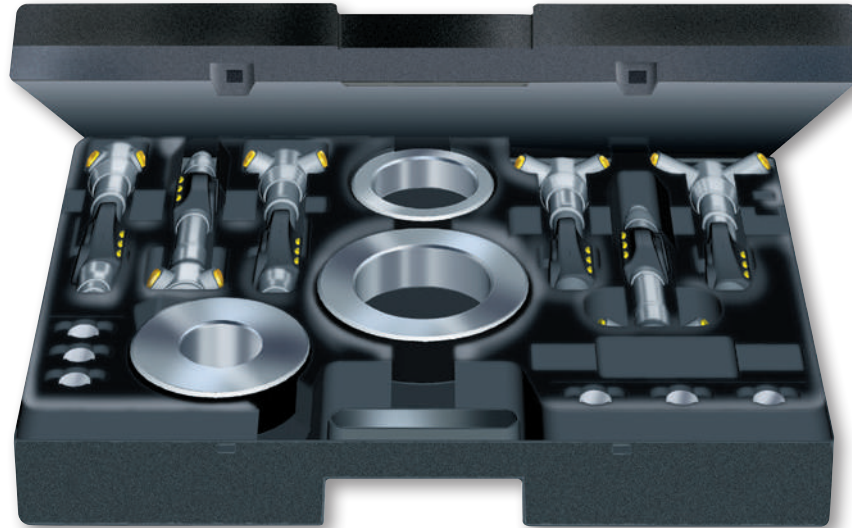

- DIN 863 T4 (Style C1)
- 0,001 mm / 0.00005 in
- LCD, 7 mm digit height
- Floating zero
- Metric/inch Conversion
- Measuring faces for application ranges 3,5 to 12 mm: hardened steel (770 HV 30)
11 to 100 mm: TIN hard-coating (2300 HV 5)
100 to 300 mm: carbide tipped (1300 HV 5)
- 3 V lithium battery
- 1 to 2 a (≈ 2000 h/a)
- Automatic shut down after 10 min. Display setting is retained as long as power supply remains stable.
- 10°C to 60°C
- 10°C to 40°C
- 80 %, non condensing
- Measuring element IP54 (IEC 60529) or IP40 with active data output
-
- Plastic case
- TESA's calibration certificate
- Declaration of conformity
- Identification number
- Display lock
- RS 232 opto-coupled, bidirectional

	mm	Singel micrometers	mm		Setting rings mm		Extensions mm
COMPOSITION OF THE SETS:							
06130220	3,5 ÷ 6,5	06130101	3,5 ÷ 4		00843200	4	
		06130102	4 ÷ 4,5		00843201	5,5	
		06130103	4,5 ÷ 5,5				
		06130104	5,5 ÷ 6,5				
06130221	6 ÷ 12	06130105	6 ÷ 8		00840101	8	00840001 100
		06130106	8 ÷ 10		00840102	10	
		06130107	10 ÷ 12				
06130222	11 ÷ 20	06130108	11 ÷ 14		00840103	11	00840301 150
		06130109	14 ÷ 17		00840104	17	
		06130110	17 ÷ 20				
06130223	20 ÷ 40	06130111	20 ÷ 25		00840106	25	00841100 150
		06130112	25 ÷ 30		00840107	35	
		06130113	30 ÷ 35				
		06130114	35 ÷ 40				
06130224	40 ÷ 100	06130115	40 ÷ 50		00840108	50	00841800 150
		06130116	50 ÷ 60		00840109	70	
		06130117	60 ÷ 70		00840110	90	
		06130118	70 ÷ 80				
		06130119	80 ÷ 90				
		06130120	90 ÷ 100				
06130225	100 ÷ 300	06130121	100 ÷ 125		00840112	125	00842600 150
		06130122	125 ÷ 150		00840113	175	
		06130123	150 ÷ 175				
		06130124	175 ÷ 200				

TESA IMICRO CAPA μ SYSTEM with Digital Display – Partial Sets

A successful combination of the TESA patented capacitive measuring system with the IMICRO unique cone.



DIN 863 T4 (Style C1)

0,001 mm / 0.00005 in

LCD, 7 mm digit height

Floating zero

Metric/inch Conversion

Measuring faces for application ranges
 3,5 to 12 mm: hardened steel (HV30 770)
 11 to 100 mm: TiN hard-coating (HV5 2300)
 100 to 300 mm: carbide tipped (HV5 1300)

3V lithium battery

1 to 2 a (\approx 2000 h/a)

Automatic shut down after 10 min. Display setting is retained as long as power supply remains stable.

-10°C to 60°C

10°C to 40°C

80 %, non condensing

Measuring element IP54 (IEC 60529) or IP40 with active data output



Plastic case

TESA's calibration certificate

Declaration of conformity

Identification number

Display lock

RS232 opto-coupled, bidirectional

No	mm	No	Elements	No	Measuring heads	mm	No	Setting rings	mm	No	Extensions	mm
COMPOSITION OF THE SETS:												
06130230	3,5 ÷ 6,5	06130010	06140020	06140021	06140022	06140023	3,5 ÷ 4	00843200	00843201	4	5,5	
			06140024	06140025	06140026	06140027	4 ÷ 4,5					
			06140028	06140029	06140030	06140031	4,5 ÷ 5,5					
			06140032	06140033	06140034	06140035	5,5 ÷ 6,5					
06130231	6 ÷ 12	06130011	06140036	06140037	06140038	06140039	6 ÷ 8	00840101	00840102	8	00840001	100
			06140040	06140041	06140042	06140043	8 ÷ 10			10		
			06140044	06140045	06140046	06140047	10 ÷ 12					
06130232	11 ÷ 20	06130011	06140048	06140049	06140050	06140051	11 ÷ 14	00840103	00840104	11	00840301	150
			06140052	06140053	06140054	06140055	14 ÷ 17			15		
			06140056	06140057	06140058	06140059	17 ÷ 20					
06130233	20 ÷ 40	06130011	06140060	06140061	06140062	06140063	20 ÷ 25	00840106	00840107	25	00841100	150
			06140064	06140065	06140066	06140067	25 ÷ 30			35		
			06140068	06140069	06140070	06140071	30 ÷ 35					
			06140072	06140073	06140074	06140075	35 ÷ 40					
06130234	40 ÷ 100	06130011	06140076	06140077	06140078	06140079	40 ÷ 50	00840108	00840109	50	00841800	150
			06140080	06140081	06140082	06140083	50 ÷ 60			70		
			06140084	06140085	06140086	06140087	60 ÷ 70			90		
			06140088	06140089	06140090	06140091	70 ÷ 80					
			06140092	06140093	06140094	06140095	80 ÷ 90					
			06140096	06140097	06140098	06140099	90 ÷ 100					
06130235	100 ÷ 300	06130012	06140100	06140101	06140102	06140103	100 ÷ 125	00840112	00840113	125	00842600	150
			06140104	06140105	06140106	06140107	125 ÷ 150			175		
			06140108	06140109	06140110	06140111	150 ÷ 175					
			06140112	06140113	06140114	06140115	175 ÷ 200					

Set available on request for extending the application range from 200 to 300 mm.



Cases for Sets of IMICRO Analogue

No	mm
00863035	3,5 ÷ 6,5
00863005	6 ÷ 12
00860008	11 ÷ 20
00860012	20 ÷ 40
00860017	40 ÷ 100
00863017	100 ÷ 200



Cases for Single IMICRO Digital Instruments

No	mm
06160002	3,5 ÷ 40
06160003	40 ÷ 70



Cases for Sets of IMICRO Digital

No	mm
06160005	6 ÷ 12
06160006	3,5 ÷ 6,5 / 20 ÷ 40
06160007	40 ÷ 100



Accessories for Both TESA IMICRO and TESA IMICRO CAPA μ SYSTEM – Extensions for Deep Hole Measurement

No	mm	A mm
00840001	6 ÷ 12	100
00840301	11 ÷ 20	150
00840302	11 ÷ 20	500
00841100	20 ÷ 40	150
00841101	20 ÷ 40	500
00841102	20 ÷ 40	1000
00841800	40 ÷ 100	150
00841801	40 ÷ 100	500
00841802	40 ÷ 100	1000
00842600	100 ÷ 300	150
00842601	100 ÷ 300	500
00842602	100 ÷ 300	1000



Centring Devices for TESA IMICRO

No	mm	A mm
00860001	40 ÷ 100	150
00862601	100 ÷ 200	200

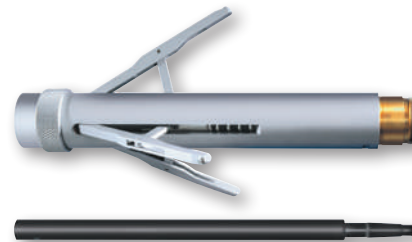

Cases for Single IMICRO Analogue Instruments

No	mm
00860007	11 ÷ 20
00860011	20 ÷ 40
00860015	40 ÷ 70
00860016	70 ÷ 100
00863016	100 ÷ 300



DIN 863 T4
(Style C1)





NFE 11-099.
Type 1 for models
6 to 10 mm or type 2
for all other models.



Measuring inserts
for application
range 6 to 10 mm:
steel, hardened to
550 HV 30.
10 to 300 mm:
tungsten carbide
tipped to HRC \geq 70.



Wooden case



Calibration
certificate
upon request



Declaration
of conformity





Identification
number

ROCH ALESOMETER with Analogue Indication, Metric

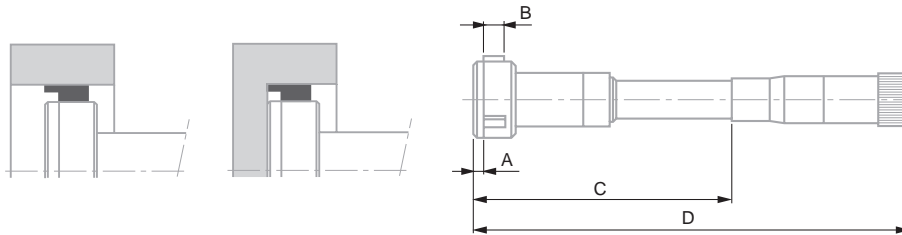
Bore gauges with 3-line contact. All ROCH ALESOMETER let you measure not only through bores, but also blind bores as well as centring shoulders, except for the models covering the application range 6 to 10 mm.



No							
	mm	mm	μ m	A mm	B mm	C mm	D mm
0081725001	6 ÷ 8	0,001	4	1,2	3	54,5	107
0081725003	8 ÷ 10	0,001	4	1,2	3	54,5	107
0081725006	10 ÷ 12,5	0,001	4	0,3	6,5	64,5	117
0081725008	12,5 ÷ 15	0,001	4	0,3	6,5	64,5	117
0081725010	15 ÷ 17,5	0,001	4	0,3	6,8	64,5	117
0081725012	17,5 ÷ 20	0,001	4	0,3	6,8	64,5	117
0081725014	20 ÷ 25	0,001	4	0,3	8,5	70	122,5
0081725016	25 ÷ 30	0,001	4	0,3	8,5	70	122,5
0081725018	30 ÷ 35	0,001	4	0,3	8,5	70	122,5
0081725020	35 ÷ 40	0,001	4	0,3	8,5	70	122,5
0081725022	40 ÷ 50	0,001	4	0,3	14,5	108,7	188,7
0081725024	50 ÷ 60	0,001	5	0,3	14,5	108,7	188,7
0081725026	60 ÷ 70	0,001	5	0,3	14,5	108,7	188,7
0081725028	70 ÷ 85	0,001	5	0,3	14,5	126,7	206,7
0081725030	85 ÷ 100	0,001	5	0,3	14,5	126,7	206,7
0081725032	100 ÷ 125	0,01	7	0,3	30	153,7	233,5
0081725034	125 ÷ 150	0,01	7	0,3	30	153,7	233,5
0081725036	150 ÷ 175	0,01	8	0,3	30	153,7	233,5
0081725038	175 ÷ 200	0,01	8	0,3	30	153,7	233,5

Face A: Not applicable for models larger than 10 mm onwards, as the measuring inserts are too close to the micrometer front face.



ROCH ALESOMETER with Analogue Indication – Full Metric Sets

Bore gauges with 3-line contact. All ROCH ALESOMETER let you measure not only through bores, but also blind bores as well as centring shoulders, except for the models covering the application range 6 to 10 mm.



- NFE 11-099. Type 1 for models 6 to 10 mm or type 2 for all other models.
- Bore related tolerance: $\pm (3 \mu\text{m} + 10 \cdot 10^{-6} D) \mu\text{m}$
- Measuring inserts for application range 6 to 10 mm: steel, hardened to 550 HV 30. 10 to 300 mm: tungsten carbide tipped to HRC ≥ 70 .
- Wooden case
- Calibration certificate upon request
- Declaration of conformity
- Identification number
- D = nominal diameter in mm ($1 \mu\text{m} + 5 \cdot 10^{-6} D) \mu\text{m}$
- Extension: hardened steel, insulated body against hand warmth. Setting rings: steel, hardened to 60 HRC.

	mm	Single bore gauges	mm	Setting rings	mm	Extensions	A mm
COMPOSITION OF THE SETS:							
0081725063	6 ÷ 10	0081725001 0081725003	6 ÷ 8 8 ÷ 10	0211625101	8	0081625081	100
0081725066	10 ÷ 20	0081725006 0081725008 0081725010 0081725012	10 ÷ 12,5 12,5 ÷ 15 15 ÷ 17,5 17,5 ÷ 20	0211625102 0211625103	12,5 17,5	0081625082	100
0081725068	20 ÷ 40	0081725014 0081725016 0081725018 0081725020	20 ÷ 25 25 ÷ 30 30 ÷ 35 35 ÷ 40	0211625104 0211625105	25 35	0081625083	150
0081725070	40 ÷ 100	0081725022 0081725024 0081725026 0081725028 0081725030	40 ÷ 50 50 ÷ 60 60 ÷ 70 70 ÷ 85 85 ÷ 100	0211625106 0211625107 0211625109	45 60 85	0081625084	150

Extensions for Depth Increase for ROCH ALESOMETERS - Analogue Models



Identification number	mm	A mm
0081625081	6 ÷ 10	100
0081625082	10 ÷ 20	100
0081625083	20 ÷ 40	150
0081625084	40 ÷ 100	150

- Hardened steel. Insulated body against hand warmth.
- Declaration of conformity
- Identification number

TESA ALESOMETER CAPA μ SYSTEM with Digital Display

Fitted with a TESA patented capacitive measuring system. Bore gauges with 3-line contact. All TESA ALESOMETER are made to measure through and blind bores as well as short centring shoulders, except for the models covering the application range from 6 to 10 mm.

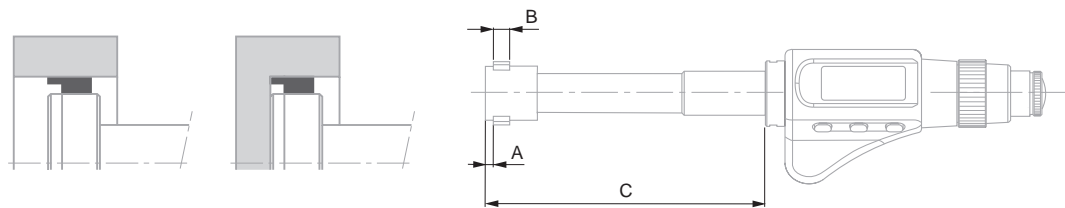

DIN 863 T4.
Style C1 for models 6 to 10 mm or style C2 for all other models.



0,001 mm /
0.00005 in



LCD, digit height
7 mm



Floating zero



Metric/inch
conversion



Measuring inserts
for application range
6 to 10 mm: steel,
hardened to
550 HV 30. 10 to 300:
tungsten carbide
tipped, HRC \geq 70.



3 V lithium battery



1 to 2 a
(\approx 2000 h/a)



Automatic shut
down after 10 min.
Display setting is
retained as long as
power supply
remains stable.



-10°C to 6°C



10°C to 40°C



80 %, non
condensing



For the measuring
element IP54
(IEC 60529) or
IP40 with active
data output



\leq 100 mm in
a plastic case
> 100 mm in
a wooden case



Inspection report
with a declaration
of conformity









Identification
number



Display lock



RS232
opto-coupled,
bidirectional

No							
06230051	6 ÷ 8	0.2362 ÷ 0.3150	4	4	1,2	3	55
06230052	8 ÷ 10	0.3150 ÷ 0.3970	4	4	1,2	3	55
06230023	10 ÷ 12,5	0.3970 ÷ 0.4921	4	4	0,3	6,5	65
06230024	12,5 ÷ 15	0.4921 ÷ 0.5905	4	4	0,3	6,5	65
06230025	15 ÷ 17,5	0.5905 ÷ 0.6890	4	4	0,3	6,8	65
06230026	17,5 ÷ 20	0.6890 ÷ 0.7874	4	4	0,3	6,8	95
06230027	20 ÷ 25	0.7874 ÷ 0.9843	4	4	0,3	8,5	100
06230028	25 ÷ 30	0.9843 ÷ 1.1811	4	4	0,3	8,5	100
06230029	30 ÷ 35	1.1811 ÷ 1.3780	4	4	0,3	8,5	100
06230030	35 ÷ 40	1.3780 ÷ 1.5748	4	4	0,3	8,5	100
06230031	40 ÷ 50	1.5748 ÷ 1.9685	4	4	0,3	14,5	140
06230032	50 ÷ 60	1.9685 ÷ 2.3622	5	5	0,3	14,5	140
06230033	60 ÷ 70	2.3622 ÷ 2.7560	5	5	0,3	14,5	140
06230034	70 ÷ 85	2.7560 ÷ 3.3465	5	5	0,3	14,5	140
06230035	85 ÷ 100	3.3465 ÷ 3.9370	5	5	0,3	14,5	140
06230036	100 ÷ 125	3.9370 ÷ 4.9212	6	6	0,3	30	175
06230037	125 ÷ 150	4.9212 ÷ 5.9055	6	6	0,3	30	175
06230038	150 ÷ 175	5.9055 ÷ 6.8897	7	7	0,3	30	175
06230039	175 ÷ 200	6.8897 ÷ 7.8740	7	7	0,3	30	175

OPTIONAL ACCESSORY

01961000 1 Lithium battery 3V, CR2032

Face A: Not applicable for models larger than 10 mm onwards, as the measuring inserts are too close to the micrometer front face.



TESA ALESOMETER CAPA μ SYSTEM with Digital Display - Partial Sets and Components

Fitted with TESA patented capacitive measuring system. Models that cover the application range from 6 to 10 mm can only measure through bores – All other partial sets also allow blind bores as well as short centring shoulders to be inspected.



DIN 863 T4.
Style C1 for models 6 to 10 mm or C2 for all other models



0,001 mm /
0.00005 in



Measuring inserts for application range 6 to 10 mm: steel, hardened to 550 HV 30. 10 to 300: tungsten carbide tipped to HRC \geq 70.



\leq 100 m in a plastic case,
 $>$ 100 m in a wooden case



Inspection report with a declaration of conformity



Identification number

No	mm	No	Measuring heads	mm	No	Connectors	No	Measuring elements	No	Setting rings	mm	No	Storage case	
COMPOSITION OF THE SETS:														
06230100	6 ÷ 10	0081720351	6 ÷ 8	0081620491	06230020	0211625101	8	06260001						
		0081720353		8 ÷ 10										
06230110	10 ÷ 20	0081720356	10 ÷ 12,5	0081620492	06230020	0211625102	12,5	06260001						
		0081720358		12,5 ÷ 15					0211625103	17,5				
		0081720360		15 ÷ 17,5										
		0081720362		17,5 ÷ 20										
06230111	20 ÷ 40	0081720364	20 ÷ 25	0081620493	06230020	0211625104	25	06260001						
		0081720366		25 ÷ 30					0211625105	35				
		0081720368		30 ÷ 35										
		0081720370		35 ÷ 40										
06230112	40 ÷ 100	0081720372	40 ÷ 50	0081620494	06230020	0211625106	45	0081629525						
		0081720374		50 ÷ 60					0211625107	60				
		0081720376		60 ÷ 70					0211625109	85				
		0081720378		70 ÷ 85										
		0081720380		85 ÷ 100										

Set available on request for extending the application range from 100 to 300 mm.



Models from
10 to 100 mm:
DIN 863 T4
(Style C2)
NFE 11-099



Max. perm. error
for models covering
the application
ranges from
5 to 40 mm = 3 μ m
40 to 100 mm = 4 μ m
100 to 200 mm = 5 μ m



Repeatability
limit for models
covering the appli-
cation ranges from
5 to 40 mm = 3 μ m
40 to 100 mm = 4 μ m
100 to 200 mm = 5 μ m



Measuring bolts
on models from
5 to 100 mm:
hardened steel.
100 to 200 mm:
tungsten carbide
tipped



Protective case
or carrying case



Inspection report
with a declaration
of conformity



Identification
number



Models from
5 to 100 mm:
0,002 mm
Models 100 to
200 mm with vernier
reading: 0,01 mm



ETALON INTALOMETER 531

Made to check through holes, blind bores and short centring shoulders. All models covering the application range up to 100 mm have sloped bolts extending beyond the front face of the measuring head.

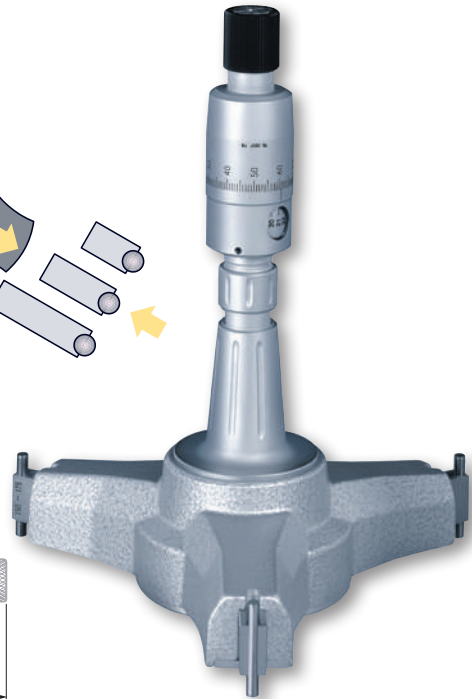
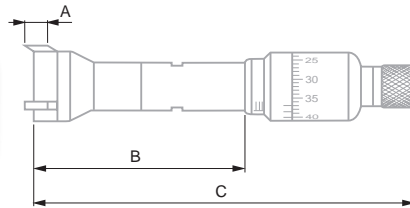
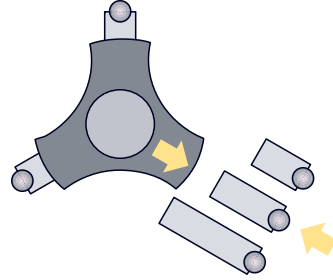

No	mm		A mm	B mm	C mm
078112356	5 ÷ 6	2 x 180°	3	≥ 32	≤ 109
078112357	6 ÷ 7	2 x 180°	3	≥ 33	≤ 111
078112358	7 ÷ 8,5	2 x 180°	4	≥ 60	≤ 130
078112359	8,5 ÷ 10	2 x 180°	4	≥ 72	≤ 133
078112360	10 ÷ 12,5	3 x 120°	3	≥ 60	≤ 118
078112361	12,5 ÷ 15	3 x 120°	3	≥ 63	≤ 120
078112362	15 ÷ 17,5	3 x 120°	3	≥ 65	≤ 122
078112363	17,5 ÷ 20	3 x 120°	3	≥ 68	≤ 125
078112364	20 ÷ 25	90°-135°-135°	7	≥ 75	≤ 132
078112365	25 ÷ 30	90°-135°-135°	7	≥ 90	≤ 138
078112366	30 ÷ 35	90°-135°-135°	7	≥ 90	≤ 142
078112367	35 ÷ 40	90°-135°-135°	7	≥ 90	≤ 148
078112368	40 ÷ 45	90°-135°-135°	10,5	≥ 110	≤ 167
078112369	45 ÷ 50	90°-135°-135°	10,5	≥ 113	≤ 170
078112370	50 ÷ 60	90°-135°-135°	15	≥ 123	≤ 187
078112371	60 ÷ 70	90°-135°-135°	15	≥ 130	≤ 193
078112372	70 ÷ 85	90°-135°-135°	15	≥ 145	≤ 213
078112373	85 ÷ 100	90°-135°-135°	15	≥ 155	≤ 224
078110733	100 ÷ 125	3 x 120°	27	≥ 105	≤ 194
078110735	125 ÷ 150	3 x 120°	27	≥ 105	≤ 194
078110737	150 ÷ 175	3 x 120°	27	≥ 105	≤ 194
078110739	175 ÷ 200	3 x 120°	27	≥ 105	≤ 194

Measuring range up to 300 mm available upon request.



ETALON INTALOMETER 531, Metric Sets

Made to check through holes, blind bores and short centring shoulders. All models covering the application range up to 100 mm have sloped bolts extending beyond the front face of the measuring head.



Models from 10 to 100mm: DIN 863 T4 (Style C2) NFE 11-099



Max. perm. error for models covering the application ranges from 5 to 40 mm = 3 µm 40 to 100 mm = 4 µm 100 to 200 mm = 5 µm



Repeatability limit for models covering the application ranges from 5 to 40 mm = 3 µm 40 to 100 mm = 4 µm 100 to 200 mm = 5 µm



Measuring bolts on models from 5 to 100 mm: hardened steel. 100 to 200 mm: tungsten carbide tipped.



Protective case or carrying case



Inspection report with a declaration of conformity



Identification number



Models from 5 to 100 mm = 0,002 mm on vernier, 100 to 200 mm = 0,01 mm

No	mm	No	Isolated instruments	mm	No	Setting rings	mm	No	Extensions	mm	
COMPOSITION OF THE SETS:											
078110592	5 ÷ 10	078112356		5 ÷ 6	00840114	6		078103613	100		
		078112357		6 ÷ 7	00840115	8,5					
		078112358		7 ÷ 8,5							
		078112359		8,5 ÷ 10							
078110594	10 ÷ 20	078112360		10 ÷ 12,5	00840116	12,5		078103621	150		
		078112361		12,5 ÷ 15	00840117	17,5					
		078112362		15 ÷ 17,5							
078110596	20 ÷ 40	078112363		17,5 ÷ 20							
		078112364		20 ÷ 25	00840106	25		078103624	150		
		078112365		25 ÷ 30	00840107	35					
		078112366		30 ÷ 35							
078110598	40 ÷ 100	078112367		35 ÷ 40							
		078112368		40 ÷ 45	00843230	45		078104940	150		
		078112369		45 ÷ 50	00843239	60					
		078112370		50 ÷ 60	00840118	85					
		078112371		60 ÷ 70							
		078112372		70 ÷ 85							
		078112373		85 ÷ 100							



DIN 863 T4
(Style C2)
NFE 11-099

000 0,01 mm

Tungsten carbide
tipped measuring
bolts and cone

Shipping box

Inspection report
with a declaration
of conformity

No
NO Identification
number

0,002 mm

Supplied with 1 heat
insulating sleeve
(No. 00940020),
2 keys (No. 00940001),
1 screwdriver
(No. 00862801).

TESA TRI-O-BOR

Self-centring and self-aligning internal micrometers with 3-line contact with the part being inspected.

These micrometers measure trough holes, blind bores and short centring shoulders.

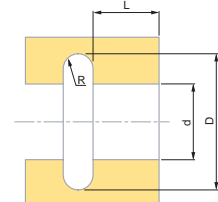
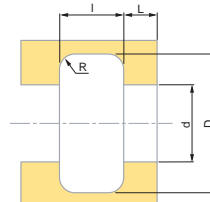
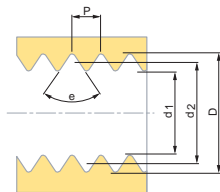
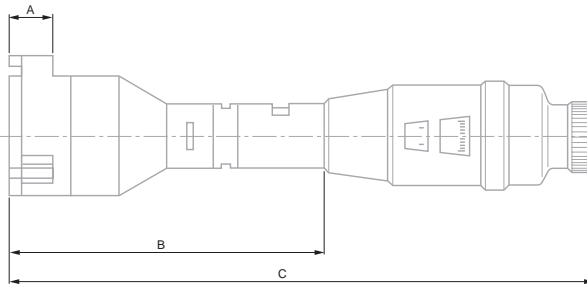
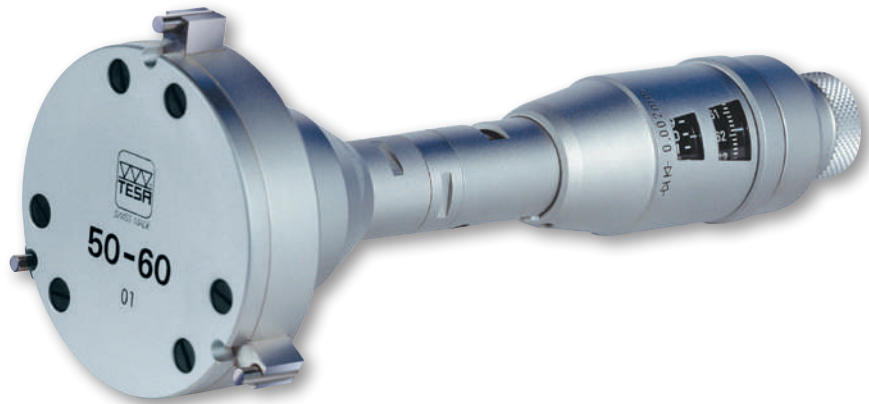

No						
	mm	µm	µm	A mm	B mm	C mm
00910005	5 ÷ 20	4	4	6	≥ 66	≤ 132
00910006	20 ÷ 25	4	4	6	≥ 66	≤ 132
00910007	25 ÷ 30	4	4	6	≥ 66	≤ 132
00910405	30 ÷ 40	4	4	10	≥ 70	≤ 138
00910406	40 ÷ 50	4	4	10	≥ 70	≤ 138
00910407	50 ÷ 60	5	5	10	≥ 70	≤ 138
00910705	60 ÷ 70	5	5	18	≥ 78	≤ 147
00910706	70 ÷ 80	5	5	18	≥ 78	≤ 147
00910707	80 ÷ 90	5	5	18	≥ 78	≤ 147
00911105	90 ÷ 100	5	5	18	≥ 78	≤ 147
00911106	100 ÷ 110	6	6	18	≥ 78	≤ 147
00911107	110 ÷ 120	6	6	18	≥ 78	≤ 147

OPTIONAL ACCESSORY

00940000 Extension of 150 mm for TESA TRI-O-BOR



TESA TRI-O-BOR, Full Sets

Self-centring and self-aligning internal micrometers with 3-line contact with the part being inspected.

These micrometers measure through holes, blind bores and short centring shoulders.

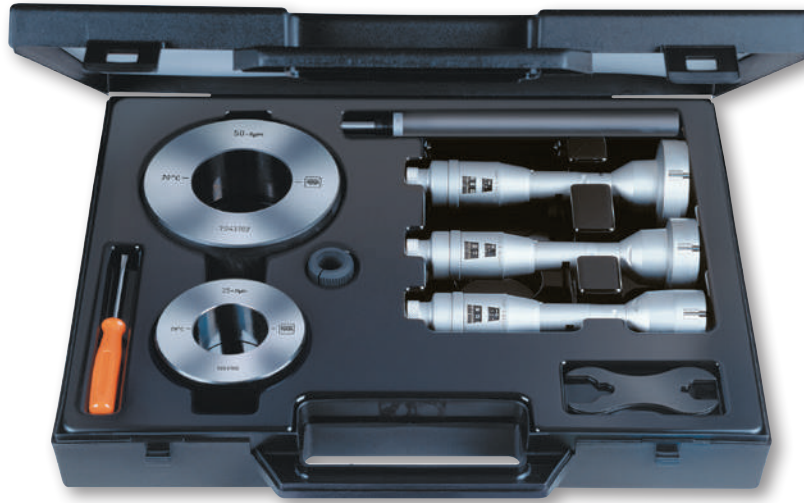

- DIN 863 T4 (Style 2) NFE 11-099
- 0,01 mm
- Tungsten carbide tipped measuring bolts and cone
- Protective case or carrying case
- Inspection report with a declaration of conformity
- Identification number
- 0,002 mm
- Supplied with 1 heat insulating sleeve No 00940020, 2 key No 00940001, 1 screwdriver No 00862801

		mm	Single micrometers	mm	Setting rings	mm	Extensions	mm
COMPOSITION OF THE SETS:								
00910004	BSC	15 ÷ 30	00910005	15 ÷ 20	00840104	15	00940000	150
			00910006	20 ÷ 25	00840106	25		
			00910007	25 ÷ 30				
00910404	BSD	30 ÷ 60	00910405	30 ÷ 40	00840107	35	00940000	150
			00910406	40 ÷ 50	00840108	50		
			00910407	50 ÷ 60				
00910704	BSF	60 ÷ 90	00910705	60 ÷ 70	00840109	70	00940000	150
			00910706	70 ÷ 80	00840110	90		
			00910707	80 ÷ 90				
00911104	BSG	90 ÷ 120	00911105	90 ÷ 100	00840110	90	00940000	150
			00911106	100 ÷ 110	00840111	110		
			00911107	110 ÷ 120				

Extension for Depth Increase TESA TRI-O-BOR



00940000	mm 150



Shipping box

No
NO Identification number

SETTING STANDARDS FOR INTERNAL MICROMETERS

TESA Setting Rings and Setting Masters

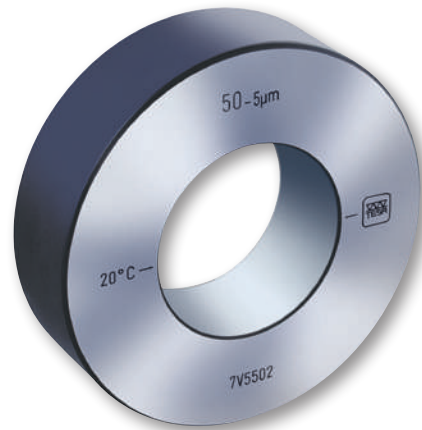

Setting ring 50 mm

Setting standard 225-275 mm

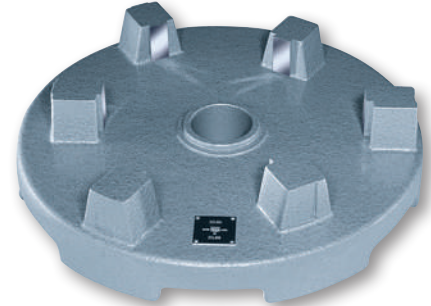

No	∅	d	µm**
	mm	µm*	µm**
00843200	4	1,5	1,5
00843201	5,5	1,5	1,5
00840114	6	1,5	1,5
00840101	8	1,5	1,5
00840115	8,5	1,5	1,5
00840102	10	1,5	1,5
00840103	11	1,5	1,5
00840116	12,5	1,5	1,5
00840104	15	1,5	1,5
00840105	17	1,5	1,5
00840117	17,5	1,5	1,5
00840106	25	1,5	1,5
00840107	35	2	2
00843230	45	2	2
00840108	50	2	2
00843239	60	2	2
00840109	70	2	2
00840118	85	2	2
00840110	90	2	2
00840111	110	2,5	2,5
00840112	125	2,5	2,5
00840113	175	2,5	4
00843101	225, 275	-	6

* Making no allowance for a rim of 1 mm.

** All listed values are determined through a 2-point measurement taken at half-height of the setting ring. The measuring direction is marked with 2 strokes. The measured actual dimension is engraved on every setting master.



