

# USER MANUAL



## MCWHU “HULK”



Revision	3.19
Last update	22/01/2016

Page intentionally left blank

INDEX

<b>1 GENERAL INFORMATION .....</b>	<b>4</b>
<b>1.1 INTRODUCTION.....</b>	<b>4</b>
1.1.1 DESIGNATION OF THE MACHINE AND MANUFACTURER DATA.....	4
1.1.2 PREMISES .....	4
1.1.3 SYMBOLS .....	5
1.1.4 GENERAL PRECEPTS .....	6
1.1.5 DESTINATION OF USE.....	6
1.1.6 TYPICAL CE CONFORMITY DECLARATION .....	7
1.1.7 MARKINGS.....	8
1.1.8 PERIODIC METROLOGICAL VERIFICATION.....	10
1.1.9 DIRECTIVES AND REFERENCE NORMS.....	10
<b>1.2 TECHNICAL FEATURES OF THE WEIGHING SYSTEM.....</b>	<b>11</b>
1.2.1 MAIN COMPONENTS.....	11
1.2.2 ELECTRONIC DEVICE FEATURES .....	13
1.2.3 ENVIRONMENTAL OPERATING FEATURES .....	13
1.2.4 REMOTE CONTROL: KEYS AND COMMANDS .....	14
1.2.5 RADIO MODULE .....	14
<b>1.3 GENERAL SAFETY NORMS .....</b>	<b>15</b>
1.3.1 LAWS AND NATIONAL NORMS.....	15
1.3.2 GENERAL WARNINGS .....	15
1.3.3 ORGANISATIONAL MEASURES OF THE USER COMPANY .....	16
1.3.4 INDICATIONS AND WARNINGS REGARDING THE CRANE SCALE .....	17
1.3.5 INDICATIONS AND BANS FOR WORKING IN SAFE CONDITIONS .....	18
1.3.6 ENVIRONMENTAL CONDITIONS.....	18
<b>2 USER MANUAL.....</b>	<b>19</b>
<b>2.1 USER .....</b>	<b>19</b>
2.1.1 PROFESSIONAL FEATURES.....	19
2.1.2 LOCATION.....	19
2.1.3 CLOTHING AND EQUIPMENT .....	19
<b>2.2 DESCRIPTION OF THE MACHINES AND CONTROLS .....</b>	<b>20</b>
2.2.1 POWER SUPPLY – START-UP – SWITCH-OFF .....	20
2.2.2 FRONT PANEL KEYS AND INDICATORS .....	21
<b>2.3 BASIC FUNCTIONS.....</b>	<b>23</b>
2.3.1 NINETEEN-KEY IR REMOTE CONTROL .....	23
2.3.2 SIX-KEY RD REMOTE CONTROL .....	24
<b>2.4 FUNCTIONING.....</b>	<b>25</b>
2.4.1 QUICK REFERENCE.....	25
2.4.2 FUNCTIONING MODES .....	26
<b>3 TECHNICAL INFORMATION.....</b>	<b>27</b>
<b>3.1 PACKAGING, TRANSPORT, HANDLING, STORAGE, AND INSTALLATION .....</b>	<b>27</b>
3.1.1 PACKAGING .....	27
3.1.2 TRANSPORT, HANDLING, STORAGE .....	27
3.1.3 INSTALLATION .....	28
<b>3.2 MAINTENANCE AND VERIFICATIONS.....</b>	<b>30</b>
3.2.1 DAILY MONITORING.....	30
3.2.2 REGULAR MAINTENANCE.....	30
3.2.3 MAINTENANCE REGISTRY .....	32
3.2.4 CLEAN .....	32
3.2.5 REPLACING THE REMOTE CONTROL BATTERIES .....	32
3.2.6 THE BATTERY RECHARGE BY OPTIONAL KIT .....	33
<b>3.3 DECOMMISSIONING AND DISPOSAL .....</b>	<b>37</b>
<b>4 WARRANTY .....</b>	<b>38</b>

# 1 GENERAL INFORMATION

## 1.1 INTRODUCTION

Dear Customer,

*We thank you for choosing a Dini Argeo product and we invite you to carefully read this manual before carrying out any operation on the instrument that you have purchased.*

*It is of utmost importance that the main checks and maintenance or repair interventions be recorded in the appropriate section of the booklet.*

*Therefore we kindly ask you to carefully keep this booklet and present it to the manufacturer Dini Argeo or to the authorised reseller each time that it is necessary to carry out maintenance, repair, or replace spare parts / accessories on the instrument.*

### NOTE:

This manual is an integral part of the instrument and if sold, it must be given to the new owner.

### 1.1.1 DESIGNATION OF THE MACHINE AND MANUFACTURER DATA

The "MCWHU" instrument is an electronic weighing device, to be considered as a lifting accessory, suitable for use on overhead cranes, or on similar lifting devices.

The MCWHU electronic crane scale consists of the following components: a double shear beam load cell, a top pivot, a lower pivot, a battery pack, and an electronic weight measurement and indication device. Normally the remote command of the measuring instrument takes place through an infrared ray system. It is possible also to use radio devices both for the remote commands as well as for the data transmission (RF). On the basis of its use, can choose the device depending on the available capacities, which in tons, are: T10, T15, T25, T35.

The instrument can be suitable for use with third parties ( M ) or for internal use.

The complete identification will then be:

MCWHU + ( 10 or 15 ) + ( M - if only for use with third parties) and MCWHU + (10 or 15 or 25 or 35) when the instrument is suitable for internal use. For more information see section "MARKINGS".

This manual takes into consideration the various types.

### MANUFACTURER'S DATA:

DINI ARGEO srl – via della Fisica , 20 - 41042 Spezzano di Fiorano (MO) - Italy

Tel. 0536-843418 Fax 0536-843521 E-mail [info@diniargeo.com](mailto:info@diniargeo.com) web [www.diniargeo.com](http://www.diniargeo.com)

### 1.1.2 PREMISES

The purpose of this manual is for the user to know all the fundamental norms and criteria for the installation, the correct use and for carrying out the correct maintenance of the purchased instrument.

Therefore:

- This manual contains all the scale's user instructions and the necessary knowledge for its correct and safe use.
- This manual supplies the useful indications for the correct functioning and maintenance of the relative electronic crane scale; it is therefore important to pay careful attention and refer to all those sections which illustrate the simplest and safest way to operate.

- This publication, or any part of it, can be reproduced without the written authorisation by the Manufacturer.

**PS:** The person responsible for the use of the weight indicator must make sure that all of the safety rules in force in the country of its use should be applied, to guarantee that the equipment is used in conformity with the use for which it is destined and avoid any dangerous situation for the users.

Any attempt of tampering or modifying the instrument by the user or non authorised personnel, or improper use, or different than what is foreseen in this manual, will relieve the Manufacturer from all responsibility in the case of damages caused by people or things.

### 1.1.3 SYMBOLS

Please find below the symbols in the manual which recall the operator’s attention, in regards to the various danger levels. The danger levels will be subdivided in four classes of importance:



**DANGER!!**



Concept or procedure which, if not carried out accurately, causes the danger or harsh personal injuries in case of accident.



**CAREFUL!!**



Concept or procedure which, if not carried out accurately, can cause harsh personal injuries or damages to the instrument in case of accident.



**CAUTION!!**



In case of an accident, concept or procedure which can cause damages to the instrument or materials or adjacent to it, if it does not carry out accurately.





**WARNING:** Important information or procedure which advises the operator regarding the optimal use of the system and on all the connected work modes.

Besides the symbols of the four different danger levels, other symbols used, will be shown:

- in the manual to recall the attention of the reader;
- on the instrument to recall the attention of the user.

Symbols used in the manual

	CE COMPLIANCE
	IDENTIFICATION OF ACCURACY CLASS.
	It means that you are describing an advance feature (hence intended for technical personnel) that will be detailed in the technical manual.



The crossed-out wheeled bin on the product means that at the product end of life, it must be taken to separate collection or to the reseller when a new equivalent type of equipment is purchased.

The adequate differentiated refuse collection in having the product recycled helps to avoid possible negative effects on the environment and health and supports the recycling of the materials of which the equipment is made. The unlawful disposal of the product by the user will entail fines foreseen by the current regulations.



It is forbidden to halt or transit under suspended load.

#### 1.1.4 GENERAL PRECEPTS

The warnings shown in this manual recall the ATTENTION OF THE OPERATOR in regards to information or procedures which advise the best use of the equipment in order to:

- work safely;
- lengthen the duration and functionality;
- avoid the damages or loss of the programming;
- optimise the work by taking into account the metric and safety norms in force in the country where it is used;



The crane scale is to be considered a scale, and therefore should only be used as a weighing instrument. Therefore any improper use, or different than what is foreseen in this manual, will relieve the Manufacturer of all responsibilities in case of damages, direct or indirect, caused to people or things.

For the indications and warnings for working in safety conditions see the “GENERAL SAFETY NORMS” section.

#### 1.1.5 DESTINATION OF USE

The “MCWHU” instrument is a non automatic weighing device, to be considered as a lifting accessory, suitable to be used on cranes, or on similar lifting devices.

In regards to the weight measurement it is possible to identify the following operating conditions:

use for determining the weight for commercial transactions.

use for determining the weight for internal use.

The name of the device models suitable to be used for commercial transactions are distinguished by a final letter M and APPROPRIATE MARKINGS (see section “MARKINGS”).

The device can be used only in ordinary work environments. For further details see section “ENVIRONMENTAL CONDITIONS”.

1.1.6 TYPICAL CE CONFORMITY DECLARATION



DICHIARAZIONE DI CONFORMITA'  
 DECLARATION OF CONFORMITY  
 KONFORMITÄTSEKTLÄRUNG  
 DÉCLARATION DE CONFORMITÉ  
 DECLARACIÓN DE CONFORMIDAD

Fabbricante: Manufacturer: Hersteller: Fabricant: Fabricante:	DINI ARGEO srl
Dinamometro elettronico modello: Electronic crane scale model: Electronische Kranwaage Modell: Dinamomètre électronique modèle: Gancho pesador electrónico modelo:	MCWHU
Anno di costruzione: Manufacturing year: Herstellungsjahr: Année de fabrication: Año de construcción:	
Numero di serie: Serial number: Seriennummer: Numéro de série: Número de serie:	

E' conforme alle direttive:

-Conforms to the directives: / Konform mit folgenden richtlinien ist: / Est conforme aux directives: / Es conforme a las directivas:

**2004/108/CE - Compatibilità Elettromagnetica**

-Electromagnetic Compatibility / Elektromagnetische Kompatibilität /

**-Con riferimento alle norme armonizzate:**

-With reference to these harmonised norms: / Mit Bezug auf die Normen: / En référence aux normes harmonisées: / Con referencia a las normas armonizadas:

**(CEI EN 61000-6-2 / 2006 ; CEI EN 61000-6-4 / 2007 ; CEI EN 61326-1 / 2007 ; CEI EN 55011 / 2009)**

**2006/42/CE - Macchine**

-Machines / Maschinen / Machines / Máquinas

**Dichiara inoltre che:**

Declares also that: / Der Hersteller erklärt außerdem, dass: / Déclare également que: / Declara también que:

**-La persona autorizzata a costituire il fascicolo tecnico presso la sede del fabbricante è la Direzione Tecnica.**

The person authorised to compose the technical file at the premises of the manufacturer is the Technical Management. / Die autorisierte Person, die die technischen Dokumente im Firmensitz des Herstellers verwaltet, ist das technische Management. / La personne autorisée à constituer le dossier technique chez la siège du fabricant est le directeur technique. / La persona autorizada a constituir el expediente técnico en la sede del fabricante es la Dirección Técnica.

Data/Date/Datum	Firma/Signature/Unterschrift
-----------------	------------------------------

### 1.1.7 MARKINGS

On the equipment one will find a label in which there are shown the metrological and technical information as well as the relative CE marking of the instrument.



For no reason the data or closing and legalisation seals on the instrument's plate, must be modified or removed. In case of tampering or removal of this information, the warranty of the instrument ceases, and the manufacturing company is released from any eventual damage, direct or indirect, caused to people or to things.

Marking for devices suitable for internal use (single scale):

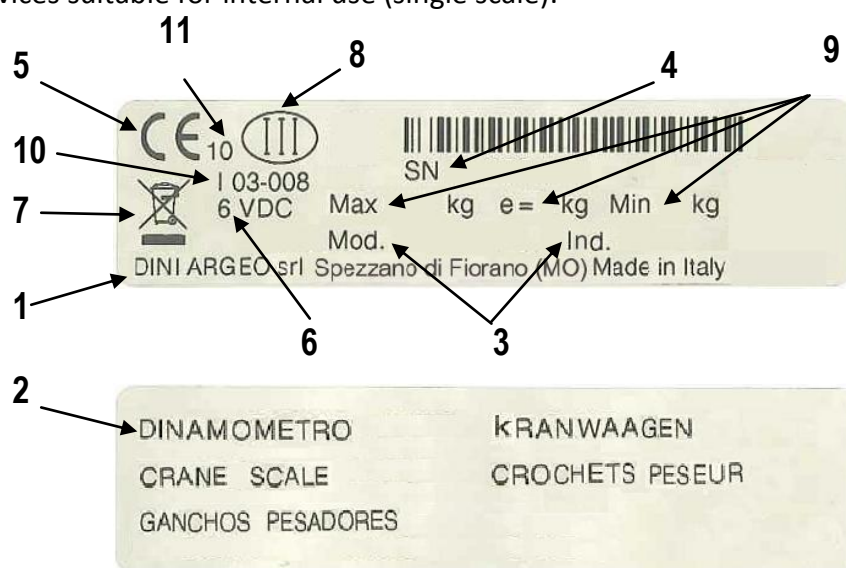

In which:

- 1 Company name and fabrication status
- 2 Name of the machine
- 3 Name of the machine model and the type of installed electronic device
- 4 Serial Number (sn)
- 5 CE Markings
- 6 Power supply voltage
- 7 Symbol of the dumpster: indicates that at the end of its useful life the product must be disposed in the appropriate waste collection bins
- 8 Instrument's precision class
- 9 Measuring field:  
Max= maximum capacity or full range of the instrument;  
Min= minimum weigh. Weighing accuracy is not guaranteed below this value;  
e= division value
- 10 Space reserved for the CE type approval certificate number
- 11 Building year of the machine



Markings for devices suitable for commercial transactions:

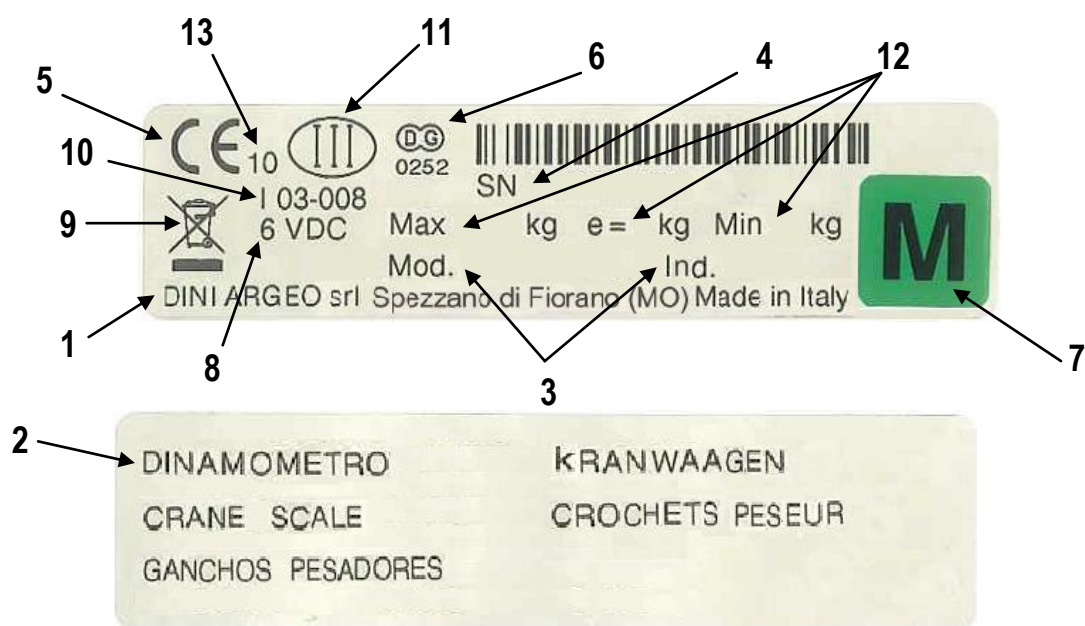

In which:

- 1 Company name and fabrication status
- 2 Name of the machine
- 3 Name of the machine model and the type of installed electronic device
- 4 Serial Number (sn)
- 5 CE Markings
- 6 Space reserved for the number of the notified body
- 7 Conformity marking (instrument subject to metrological check)
- 8 Power supply voltage
- 9 Symbol of the dumpster: indicates that at the end of its useful life the product must be disposed in the appropriate waste collection bins
- 10 Space reserved for the CE type approval certificate number
- 11 Instrument's precision class
- 12 Measuring field:
  - Max= maximum capacity or full range of the instrument;
  - Min= minimum weigh. Weighing accuracy is not guaranteed below this value;
  - e= division value
- 13 Building year of the machine

Markings on the load cell:

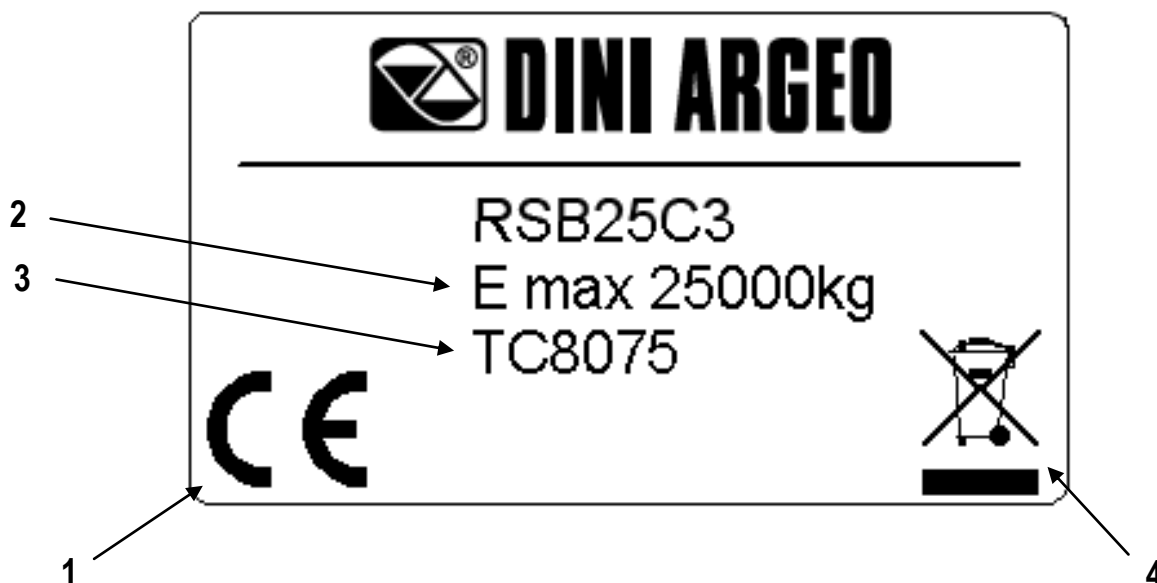

In which:

- 1 CE marking
- 2 Name of the series or model of the load cell
- 3 Maximum useful load (maximum capacity)
- 4 With the issuing of the July 22nd, 2005 nr. 151 decree-law, relative to the European Directive 2002/96/EC in regards to the Waste Electrical and Electronic Equipment (known as WEEE), the relative manufacturers are called to intervene and manage the life cycle end of their introduced products. All the WEEE products must have impressed an easily visible and undeletable crossed-out dumpster. Therefore the manufacturers must offer all the instruments necessary for a correct disposal of this equipment.

### 1.1.8 PERIODIC METROLOGICAL VERIFICATION

For all weighing instruments used in commercial transactions, it must be ascertained that the metrological features and the measurement reliability are kept in time. A periodic metrological verification is, therefore compulsory; the periodicity and the verifying person depend on the laws / regulations of the country in which one is operating.

### 1.1.9 DIRECTIVES AND REFERENCE NORMS

List of the EC directives taken into reference:

- 2009/23/EC (Non automatic weighing instruments)
- 2004/108/EC (Electromagnetic compatibility)
- 2006/95/EC (Low Voltage)
- 2006/42/EC (Machines)
- 1999/5/EC (Radio equipment); only version with radio module
- 2002/95/EC ; 2003/118/EC ; 2002/96/EC ( RoHS and WEEE )

List of norms or other documents taken into reference:

- FEM1.001
- CEI EN 61000-6-2 / 2006
- CEI EN 61000-6-4 / 2007
- CEI EN 61326-1 / 2007
- CEI EN 55011 / 2009
- 1999/519/EC recommendation (only version with radio module)
- ETSI EN 301489-3 1.4.1 version (only version with radio module)
- ETSI EN 300220-2 2.1.1 version (only version with radio module)

## 1.2 TECHNICAL FEATURES OF THE WEIGHING SYSTEM

### 1.2.1 MAIN COMPONENTS

The “MCWHU” instrument is an electronic weighing device. In order to better understand this product, please find below the main components which are part of this machinery.

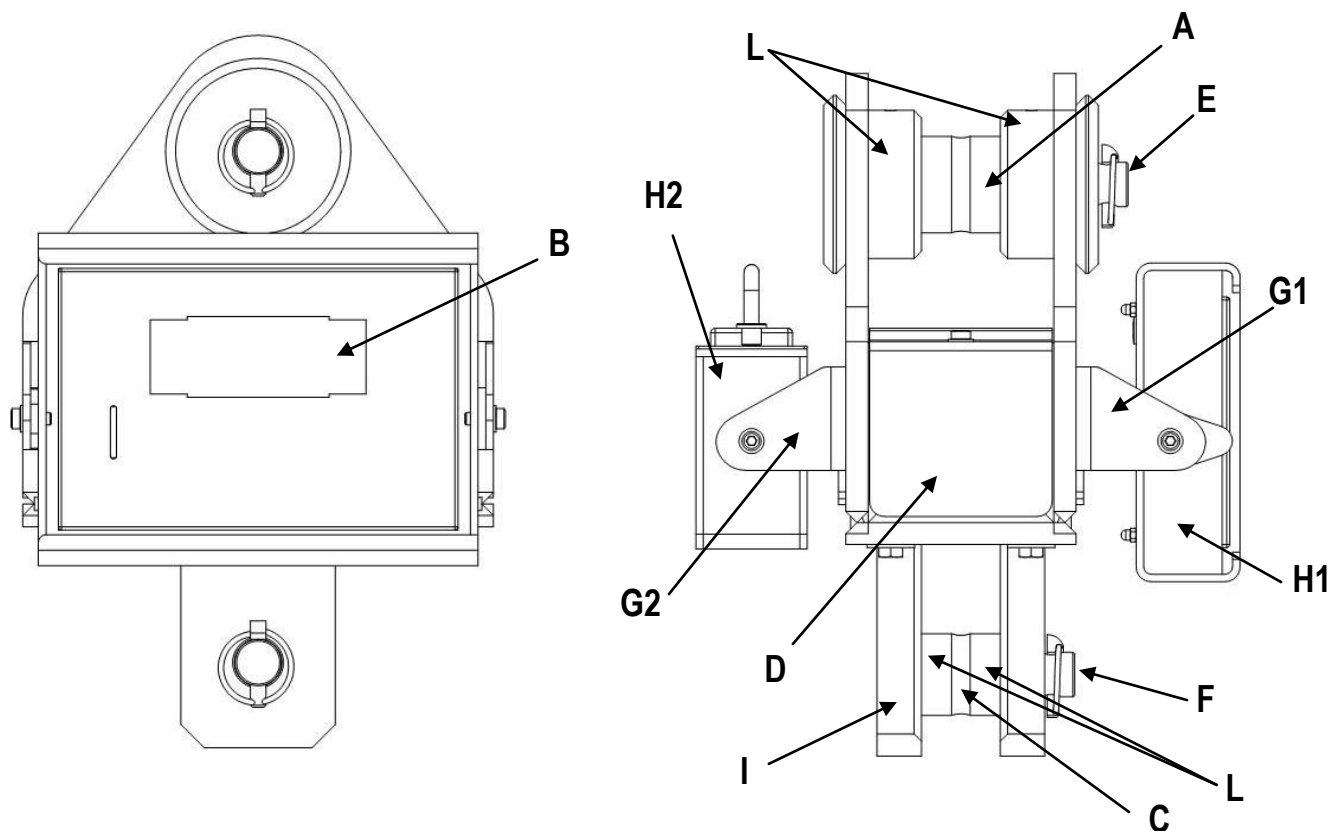

- A:** top pivot for connecting the connection ring and the device block;
- B:** electronic device for converting the signal coming from the transducer into a weight unit, with measurement display, and command and adjustment systems; shackle for connection between the lifting device hook and the load cell;
- C:** lower pivot for the connection of swivel hook and the device fork;
- D:** protective box containing load cell and its relative blocking pivots;
- E:** top pivot lockpin;
- F:** lower pivot lockpin;
- G1:** indicator holding bracket;
- G2:** battery holding bracket;
- H1:** weight indicator block;
- H2:** battery box;
- I:** fork for the connection between the lower pin and the load cell;
- L:** spacers pivot upper/lower and centering washers for upper hook and lower hook;

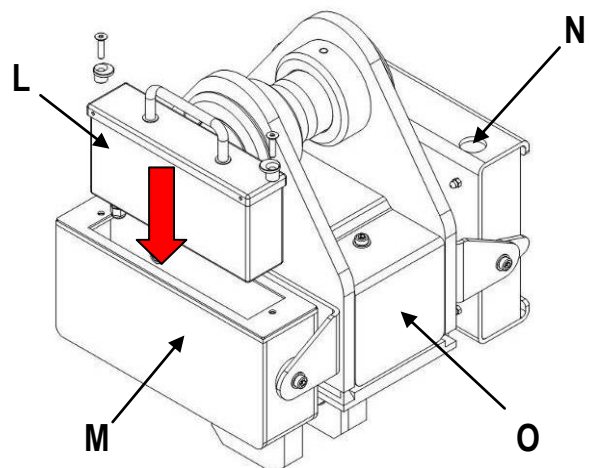

INDICATOR BLOCK REAR

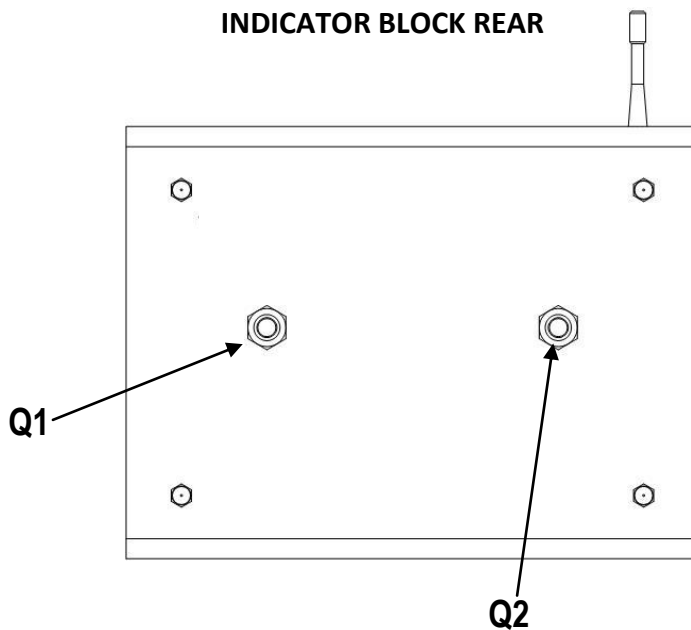

- L:** is the battery box and its direction of insertion into the MCWHU electronic crane scale;
- M:** is the box in which the battery pack is placed. The box is located on the rear of the machine;
- N:** the hole for the antenna output (this version with radio module);
- O:** body in which there is the double shear beam load cell;
- Q1:** PG9 cable gland for connecting the indicator block and the battery pack;
- Q2:** PG9 cable gland for connecting the indicator block and the load cell;

For more information concerning the battery and its features, see paragraph “ELECTRONIC CRANE SCALE BATTERY: INSTRUCTIONS AND RECHARGE”.

## 1.2.2 ELECTRONIC DEVICE FEATURES

PRECISION	+/- 0,05% of full capacity
PROTECTION DEGREE	IP 67
POWER SUPPLY	6 Vdc -12 Ah sealed rechargeable internal battery, standard, range of about 130 hours. 12 Vdc with external power supply 100÷240 Vac (50÷60 Hz)/12 Vdc standard.
DISPLAY	DOT LED 6 digits 40 mm high.
KEYBOARD	Water resistant key polycarbonate membrane with tactile feedback. Plexiglas screen protection for the display and keyboard.
AUTO POWER OFF	Adjustable from 1 to 255 minutes of no use, disinsertable.
LOW BATTERY WARNING	"Low bat" shown on the display.
MEASUREMENT UNIT AVAILABLE	g= grams, kg= kilograms, t= tons, Lb= pounds.
IN CALIBRATION PHASE CONTAINER	Sturdy stainless steel, for protection from dust and splashes. Extremely sturdy oven painted steel case
I/O SECTION	- 1 RS232/TTL input/output - 1 RS232 input/output for connection to PC/PLC

**THE PARTS OF THE INSTRUMENT CONTAINING DANGEROUS ELECTRICAL TENSION ARE ISOLATED AND INACCESSIBLE TO THE USER UNLESS IT HAS BEEN DAMAGED, OPENED, OR ALTERED.**

## 1.2.3 ENVIRONMENTAL OPERATING FEATURES

OPERATING TEMPERATURE	From -10 to +80°C with optional heat shield (-10/+40°C in CE-M approved version).
RELATIVE HUMIDITY	From 10 to 85 % without condensation

### 1.2.4 REMOTE CONTROL: KEYS AND COMMANDS

Along with the “MCW” electronic crane scale, an infrared remote control is supplied in which it is possible to repeat the keyboard functions. Optionally it is possible to have a 6-key radio remote control.

The type of remote control to be used must be selected in the Setup environment, in the << **ir.ConF** >> step.

**NOTA: Infrared remote controls are for internal use only.**



**CAUTION !!**



Do not press the keys with hard and/or pointed objects; only use fingers.

The configuration instructions are described in section “FUNCTIONING WITH REMOTE CONTROL”.

### 1.2.5 RADIO MODULE

The radio module version allows communicating in radio frequency with eventual external devices (PC, printer or weight repeater); it is fitted with two multipoint radio frequency modules; one is installed on the measurement device and the other on the remote unit.

The multi channel radio module functions in a frequency band, without need of license.

WORK FREQUENCY

From 868 to 870 MHz

## 1.3 GENERAL SAFETY NORMS

The user must respect the manufacturer's prescriptions of the crane scale; one must respect the prescriptions requested by the manufacturer of the lifting device, and those highlighted in the eventual safety data sheet of the product which must be weighed.

### 1.3.1 LAWS AND NATIONAL NORMS

Before putting into service and while using it, the user must ascertain that all norms in force in the country, where the instrument is used in regards to "safety and prevention of casualties" and "metrology", are respected.

It is also important to take into account and respect the laws and prescriptions of the Bodies assigned to the safety control of the country of use.

### 1.3.2 GENERAL WARNINGS

- DO NOT exceed the nominal capacity of the crane, of the scale or of any support element of the load fixed onto the scale.
- Use the scale EXCLUSIVELY for the lifting and the weigh of suspended loads and for TENSION measurements.
- Suspended loads which may cause applied torsion stresses MUST be hanged with flexible or swivelling bindings.
- Carefully respect all the safety measurements established by the manufacturer of the electronic crane scale, which are shown in the instruction manual.
- It is severely forbidden to exceed the nominal capacity of the crane, the scale, or any support element of the load that is fixed onto the scale.
- The electronic crane scale is to be considered a scale, and therefore should only be used as a weighing instrument. Therefore any improper use or use that is different than what is foreseen, will relieve the Manufacturer from all responsibilities in case of damages caused to people or things.
- Entrust the installation, set-up, maintenance, operations only to specialised personnel.



The crane scale is to be considered like an actual scale, and therefore it must be used only as a weighing instrument. Therefore, an improper or different use than what is foreseen in this manual, will release the Manufacturer from all responsibilities in case of damages caused to people or things.

### 1.3.3 ORGANISATIONAL MEASURES OF THE USER COMPANY

- Respect the safety measures established by the manufacturer of the electronic crane scale, the manufacturer of the lifting device, and eventually of the safety board of the product to be weighed.
- The electronic crane scale must be used only for the foreseen purposes.
- Entrust the use of the instrument only to expert and trained people, also with experience in using the lifting equipment.
- Entrust the execution of installation, putting into function, maintenance, and repair operations only to specialised personnel (section “MAINTENANCE AND VERIFICATIONS”).
- Make sure that the user manual is always available where the scale is used.
- Carefully read and apply what described in the section “POWER SUPPLY – START-UP – SWITCH-OFF”.
- The nominal capacity of the scale must be equal or greater than the crane. If the nominal capacity of the scale is greater than the maximum capacity of the crane, make sure that loads, which are greater than the maximum capacity of the crane or of any support element of the load, are lifted.
- Use only original spare parts.
- All the indicator connections must be made respecting the norms applied in the installation zone and environment.
- Periodic verification with registry.
- The electronic crane scale must be submitted to regular maintenance and repair interventions (see section “MAINTENANCE AND VERIFICATIONS”).
- File the test result and conserve it in the test register.
- When one notices anomalies while using the electronic crane scale, IMMEDIATELY stop all operations and do not reuse the instrument until the instrument has been submitted to specific controls by specialised and authorised personnel or by Dini Argeo service assistance personnel.



Incorrect use, but reasonably foreseeable, by untrained people entails a non acceptable residual risk.



### 1.3.4 INDICATIONS AND WARNINGS REGARDING THE CRANE SCALE

- It is strictly FORBIDDEN for non authorised personnel to enter in the operating zone.
- It is strictly FORBIDDEN to walk or halt below or near suspended loads.
- It is strictly FORBIDDEN to exceed the nominal capacity of the crane, the scale or of any load support element fixed to the scale.
- It is strictly FORBIDDEN to lift loads exceeding the maximum capacity of the MCWHU, which is shown on the sides of the instrument.
- The crane scale is to be considered a scale, for all purposes, and therefore should only be used as a weighing instrument.
- Use ONLY the scale to weigh suspended loads and to make tension measurements.
- Place the crane so that the load is lifted vertically.
- Place the load without causing knocks using a low speed of the crane.
- Once the load harnessing operation is done, move away, and make sure that the load is well balanced lifting it up a few centimetres from the ground.
- Use structures with single hitch elements which allow a correct alignment of the scale.
- Do not use structures with single hitch large-sized elements which could block the correct alignment near the hitch point.
- Suspended loads which can cause applied torsion stresses MUST be hanged with flexible or swivelling bindings.
- It is FORBIDDEN to make oblique moves on the load.
- Carefully read and apply what described in section "POWER SUPPLY – START-UP – SWITCH-OFF".
- Periodically check the integrity of all the scale parts (see section "MAINTENANCE AND VERIFICATIONS").
- Any maintenance, repair, or cleaning operations must be made with the electronic crane scale turned off (see section "MAINTENANCE AND VERIFICATIONS").
- Use the DPI prescribed by the manufacturer of the lifting system and eventually those highlighted in the safety data sheet of the weighing article (helmet, accident-prevention shoes, etc.).



**DANGER!!**



The nominal capacity of the electronic crane scale must not be lower than the maximum capacity of the lifting device. If one attaches a crane scale with a nominal capacity less than the nominal capacity of the lifting device, verify it with another weighing system, making sure that the load to be weighed is not greater than the nominal capacity of the electronic crane scale.

### 1.3.5 INDICATIONS AND BANS FOR WORKING IN SAFE CONDITIONS

- It is FORBIDDEN to use the equipment for lifting or transporting people.
- It is FORBIDDEN to pull or drag loads, but only to apply vertical forces.
- DO NOT exceed the rated capacity of the crane, scale or any bearing element attached to the scale.
- DO NOT swing the load by pushing it or putting it beyond the work area of the lifting device.
- DO NOT use multiple attachment points.
- DO NOT push nor pull the load or the loaded scale.
- DO NOT pull the hook from the side.
- It is FORBIDDEN to use the device for weighing radioactive materials or melted masses.
- DO NOT stretch obliquely the load.
- It is FORBIDDEN to make any changes to the scale.
- DO NOT spill liquid on the instrument.
- DO NOT use solvents or industrial chemicals for cleaning the instrument

### 1.3.6 ENVIRONMENTAL CONDITIONS

- DO NOT install in an area with risk of explosion.
- DO NOT expose the instrument to strong magnetic or electrical fields.
- DO NOT install the instrument in an environment at risk of corrosion.
- It is FORBIDDEN to use the device beyond the temperature range from  $-10^{\circ}\text{C}$  to  $+80^{\circ}\text{C}$  with the optional heat shield and with the optional heat shield and  $-10/+40^{\circ}\text{C}$  in the approved version CE-M.

# 2 USER MANUAL

## 2.1 USER

### 2.1.1 PROFESSIONAL FEATURES

The staff assigned to the electronic crane scale and all activities related to it must:

- Have appropriate physical and mental characteristics;
- Be an expert or have sufficient knowledge on lifting equipment and be trained in the proper use of scales;
- Be familiar with the requirements of labour protection and accident prevention in the field;
- Be able to evaluate the safety condition of the lifting equipment;
- Understand the safety signs on the machine, the warnings and the messages highlighted in the manual of the instrument, even if he does not have a good command of the language in which the crane operates;
- Be able to make oneself understood in the workplace.

### 2.1.2 LOCATION

The operator of lifting equipment, which was installed on the crane scale, must not only respect the safety conditions but is also responsible for accidents that may occur around the machine.

Therefore, the operator must place himself in a working position which is safe for people, things, and vehicles in the workplace. In particular, the operator must:

- Be very careful to never position below the load or in positions which could be dangerous if there was a rupture of an accessory of lifting equipment;
- Always have a good visibility of the load and eventual personnel nearby;
- Evacuate the people and things from the work area;

### 2.1.3 CLOTHING AND EQUIPMENT

The personnel must wear clothing and be fitted with personal protective equipment required for the lifting vehicle used (helmets, protective gloves, safety shoes, etc..)

## 2.2 DESCRIPTION OF THE MACHINES AND CONTROLS

### 2.2.1 POWER SUPPLY – START-UP – SWITCH-OFF

The instrument is powered by a 6 VDC internal rechargeable battery.

It is possible to charge the battery through the 12V power adapter (supplied) which should be connected to the 230 Vac mains voltage.

**TO TURN ON** the instrument press the C key until the indicator turns on; then release.

The display shows in sequence:

**HH.YY** is the installed software version.

**bE HHH** in which **HHH** is a number from 0 to 100 which indicates the battery level.

The indicator has an “auto zero at start-up” function: in other words it means that if at start-up a weight within +/- 10% of the capacity is detected, it will be zeroed; if the weight is not within this tolerance, with a non approved instrument the display shows the present weight after a few instants, while with an approved instrument “ZEro” is shown continuously on the display, until the weight does not re-enter within this tolerance; the auto zero function at start-up may be disabled in the set-up environment (only with non approved instrument); see **SEtuP → ConFiG → PArAM. → Auto-0** ().

By pressing the **ZERO** key for an instant while the version is shown in the LED display, the indicator will show the following in this order:

**Clock** if there is the optional board with date and time.

**HH.YY** in which **HH** indicates the instrument type, **YY** indicates the metrological software version.

**HH.YY.ZZ** is the installed software version.

**HHHHHH** is the name of the installed software.

**bE HHH** in which **HHH** is a number from 0 to 100 which indicates the battery level.

**-K- H.YY** in which **K** identifies the type of keyboard: K=0 5-key keyboard, K=1 17-key keyboard.  
**H.YY** is the installed software version.

After this, “**h rES**” is displayed (in case of non approved instrument) or “**LEGAL**” and the g gravity value (in case of approved instrument), then the programmed capacity and minimum division, and finally it executes a countdown (self-check).





**TO TURN OFF** the instrument keep the **C** key pressed until the “- OFF -” message appears on the display; then release the key.

## 2.2.2 FRONT PANEL KEYS AND INDICATORS

The front panel is projected in order to make easy and immediate use of the indicator by the user; it consists of a display 6 DOT LED 40mm high digits, 7-LED indicators and a waterproof film keypad at 5 keys.

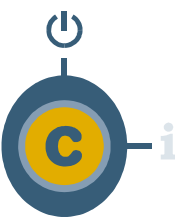

- ① Indicates the presence of power supply.
- ② Sensor for the reception of the infrared signal.
- ③ Indicates that the weight detected by the weighing system is close to zero, within  $\pm\frac{1}{4}$  of the division.
- ④ Indicates that the weight is unstable.
- ⑤ Indicates that the displayed value is a net weight.
- ⑥ Indicates the unit of measure in use and that one is in the first weighing range.
- ⑦ Indicates the unit of measure in use and that one is in the second weighing range.
- ⑧ Indicates that a specific function of the indicator is active.

SCALE KEY	FUNCTION
<p><b>ZERO</b></p> 	<ul style="list-style-type: none"> <li>- Zeros the displayed gross weight, if it is within +/- 2% of the total capacity.</li> <li>- Cancels the negative tare value.</li> <li>- When entering numbers it decreases the digit to be modified.</li> <li>- If pressed for a long time, it allows to enter the MENU of the user (see paragraph "USER MENU").</li> </ul>
<p><b>TARE</b></p> 	<ul style="list-style-type: none"> <li>- If pressed for an instant it carries out the semiautomatic tare.</li> <li>- If pressed at length it allows entering the manual tare from keyboard.</li> <li>- Cancels the negative tare value.</li> <li>- In the numeric input phase it increases the digit to be modified.</li> </ul>
<p><b>MODE</b></p> 	<ul style="list-style-type: none"> <li>- It carries out a specific function of the operating mode set in the set-up environment.</li> <li>- In the numeric input phase it selects the digit to be modified, from left to right.</li> </ul>
<p><b>PRINT</b></p> 	<ul style="list-style-type: none"> <li>- It carries out a specific function of the operating mode set in the set-up environment.</li> <li>- In the numeric input phase, it confirms the entry made.</li> <li>- In the SET-UP, it allows to enter a step or to confirm a parameter within a step.</li> <li>- It transmits the data from the serial port dedicated to the printer.</li> </ul>
	<ul style="list-style-type: none"> <li>- It turns the instrument on and off.</li> <li>- In the numeric input phase, it quickly zeros the present value.</li> <li>- In the SET-UP, it allows to exit a step without confirming the change made</li> <li>- Allows viewing the scale's metric information: capacity, division, minimum weigh for each configured range.</li> </ul>

## 2.3 BASIC FUNCTIONS

### 2.3.1 NINETEEN-KEY IR REMOTE CONTROL

The remote control is designed for indoor use / not in the light of the sun

The command system is “directive”, therefore the receiving measurement device must be “in view”; the maximum functioning distance is 8 m. With this type of remote control, the functioning of the keys will be as described in the following table.

#### FUNCTION OF THE KEYS

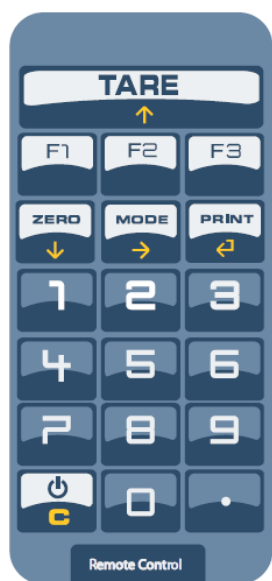

REMOTE CONTROL KEY	KEY OR FUNCTION EMULATED
<b>F1</b>	It allows to select the desired function; see section “ADDITIONAL FUNCTIONS WITH THE 18-KEY AND 19-KEY REMOTE CONTROLS”. If pressed at length it changes the display intensity.
<b>C</b>	C key or stand-by function if pressed at length.
<b>NUMERIC KEYS</b>	Entry of digits.
<b>TARE / ▲</b>	Tare key or increase of a digit while entering a value.
<b>.</b>	. or display of scale info.
<b>ZERO / ▼</b>	Zero key or decrease of a digit while entering a value.
<b>MODE / →</b>	Mode key or it scrolls the digits to the right while entering a value.
<b>PRINT / ←</b>	Print or enter key.
<b>F2</b>	Not managed.
<b>F3</b>	Not managed.

To enable this mode one has to select “ir 19” in the ir.ConF step.

### 2.3.2 SIX-KEY RD REMOTE CONTROL

Through the remote control with 6 buttons is possible to remotely functionality of the ZERO, TARE, MODE, ENTER / PRINT, C / DEL, and F / Fn, keys or just the TARE key, depending on the operating mode set (  ).

The remote control keys repeat the keys' functions (both the ones obtained with a SHORT pressing as well as those with a LONG pressing) and they correspond to the following indicator keys:

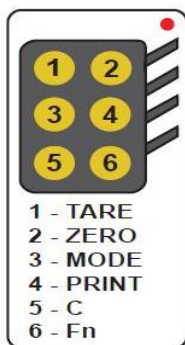

REMOTE KEY	"TARA" Mode	Complete mode
1 - TARE	TARE	TARE
2 - ZERO	TARE	ZERO
3 - MODE	TARE	MODE
4 - PRINT	TARE	ENTER/PRINT
5 - C	TARE	C
6 - Fn	TARE	F/Fn

In the "complete" mode, by holding down the C key, you can put the instrument in stand-by mode; by pressing C on the keyboard or any button on the remote control, you will returns to weighing mode.

While setting up the remote control (  ) is also possible select whether:

- a) Use multiple remotes with a single indicator, without associating to it, therefore without limit the number of remote controls used.
- b) Use different indicators in the same area, matching each remote control to the desired indicator, in order to execute the function only on it and thus avoid that the function is repeated on all indicators in use.  
Enabling this feature i t will be possible to combine up to 3 different remote controls (eg. for 3 different operators) for each indicator.

It's possible to link a new remote control with TARE key and ZERO key pressed at length (3 seconds). When the instrument displays "Aut .rd?" by pressing ENTER key of the keyboard the new remote control is linked.

With C key of the keyboard, if the serial number exists, the remote control is removed.



## 2.4 FUNCTIONING

- 1) Suspend the instrument from the crane it will be used on and press push-button "C" for a few seconds: all segments on the display will light for a few seconds as the MCW conducts a lamp and other self-tests.
- 2) After the self-tests, if the display shows a non-zero value without a load on the scale, press the "ZERO" key.
- 3) If any accessories have been applied to the MCW (connection rings, chains, hooks etc.) it is necessary to press the "TARE" key (or by using the remote control's TARE button).

**NOTES:**

- The "TARE" key can be used with any weight applied in the range of its capacity.
  - If slings are used to handle the load, make sure that the load is properly balanced and that the slings are positioned properly.
- 4) When the display indicates "0 ", the instrument is ready for use.
  - 5) Start lifting the load slowly.
  - 6) If the load is greater than the full-scale value (not maximum capacity), the display will show " - - - - - ", which means overload. Unload to avoid any need for recalibration.
  - 7) To switch off the instrument, keep the C key pressed until the – *OFF* – message appears on the display.







**DANGER!!**





























If, during the weighing operations with the crane scale, one views the " - - - - - " (Over Load) message, one should IMMEDIATELY stop the weighing operations and quickly place on the ground the load attached on the crane scale.

### 2.4.1 QUICK REFERENCE

 <b>TARE</b> Press → TARE Press 2 sec → MANUAL TARE (PT)	 <b>MODE</b> Press → ENABLE SELECTED MODE
 <b>PRINT ENTER</b> Press → CONFIRM Press → PRINT	 Press → CANCEL Press 2 sec → ON / OFF Press 3 sec → <b>INFO: Max, Min, e</b>

2.4.2 FUNCTIONING MODES

<b>STANDARD</b>	 <u>MODE</u>	Press →	SWITCH Kg / Lb
<b>NET / GROSS</b>	 <u>MODE</u>	Press →	SWITCH NET / GROSS
<b>SETPOINT</b>	 <u>PRINT</u> <u>ENTER</u>	Press 2 sec →	TYPE VALUE  <u>PRINT</u> <u>ENTER</u>
<b>IN / OUT</b>	 <u>MODE</u>	Press →	IN WEIGH  Press →
<b>ALIBI MEMORY</b>	 <u>MODE</u>	Press →	TYPE REWRITING ID  <u>PRINT</u> <u>ENTER</u> → TYPE ID  <u>PRINT</u> <u>ENTER</u>
<b>TOLERANCE CHECK</b>	 <u>MODE</u>	Press →	TARGET  <u>PRINT</u> <u>ENTER</u> → TOL.-  <u>PRINT</u> <u>ENTER</u> → TOL. +  <u>PRINT</u> <u>ENTER</u> → MIN WEIGHT  <u>PRINT</u> <u>ENTER</u>
<b>PERCENTAGE</b>	 <u>MODE</u>	Press →	TYPE % VALUE  <u>PRINT</u> <u>ENTER</u> →  <u>MODE</u> Press → SWITCH %- WEIGHT
			 <u>MODE</u> Press 2 sec → SAMPLE
<b>DISPLAY x10</b>	 <u>MODE</u>	Press →	ENABLE / DISABLE x10
<b>HOLD or PEAK</b>	 <u>MODE</u>	Press →	ENABLE / DISABLE HOLD or PEAK
<b>TOTALISER</b>	 <u>MODE</u>	Press →	SINGLE WEIGHING
	 <u>PRINT</u> <u>ENTER</u>	Press →	TOTAL  Press 2 sec → GRAND TOTAL
<b>PIECE COUNTING</b>	 <u>MODE</u>	Press →	TYPE PCS NR.  <u>PRINT</u> <u>ENTER</u> →  <u>MODE</u> Press → SWITCH PCS - WEIGHT
			 <u>MODE</u> Press 2 sec → SAMPLE

# 3 TECHNICAL INFORMATION

## 3.1 PACKAGING, TRANSPORT, HANDLING, STORAGE, AND INSTALLATION

### 3.1.1 PACKAGING

The equipment is supplied on a standard wooden pallet arranged for the transport of the instrument.

In the packaging of the "MCWHU" instrument, the following material is supplied:

- Sheet metal for transport.
- External power (12Vdc)
- Infrared remote control.
- Instruction manual (CD or paper).
- Certificate of calibration.
- Certificate of internal control of the manufacturer (which serves as a reference for periodic inspections).
- CE Declaration of Conformity.
- REGISTER FOR MAINTENANCE AND WARRANTY.

Before making the first user verification, make sure that the package contains all the items in the above list and that the material has not been damaged during the transport.

### 3.1.2 TRANSPORT, HANDLING, STORAGE

The transport of electronic crane scale must be made by using its own wooden pallet.

The wooden pallet foresees the lifting through forks in order to ease the transport of the electronic crane scale; this also protects the instrument from knocks and possible falls.

During the transportation, one must take into consideration that the packaging should not be compressed neither from above or from the side from any external bodies.

It is important that the wooden pallet and the electronic crane scale itself are stored in enclosed spaces that meet the environmental conditions mentioned above (see paragraph "ENVIRONMENTAL CONDITIONS").

MODEL	SIZES mm (l x w x h)	WEIGHT
MCWHU10	620X670X120	88 kg
MCWHU15	620X670X120	88 kg
MCWHU25	620X670X120	88 kg
MCWHU35	620X670X120	88 kg

Sizes:

Length (l) x width (w) x height (h)



**CAREFUL!!**



Take care when handling the pallet in order to avoid collisions or falls that could be harmful to humans and/or instrument.

If necessary, execute the procedure for handling with the help of several people or with appropriate aid.

### 3.1.3 INSTALLATION

In the wooden pallet used for the transport of the instrument, all system components are included. The equipment is not supplied ready to use, so it is necessary to perform some operations to enable the functioning of the machine.

The installation steps are:

- Open the wooden box containing the electronic crane scale.
- Install the "shackle" on top of the load cell.
- Install the "shackle" on the bottom of the load cell.
- Replace the metal used for the transport of the instrument.
- Insert a ring inside the upper pin.
- Attach the spacers of the top pivot using the supplied screw.
- Position the as shown in the next figure:

Centering washers  
of the upper hook

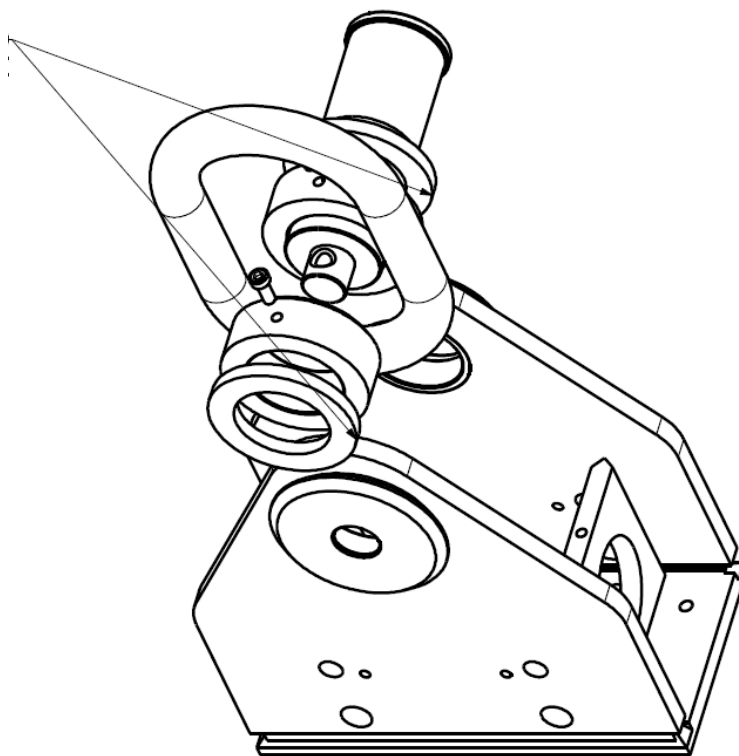

- Insert the swiveling hook in the lower pivot with its centering washers as shown in the next figure:

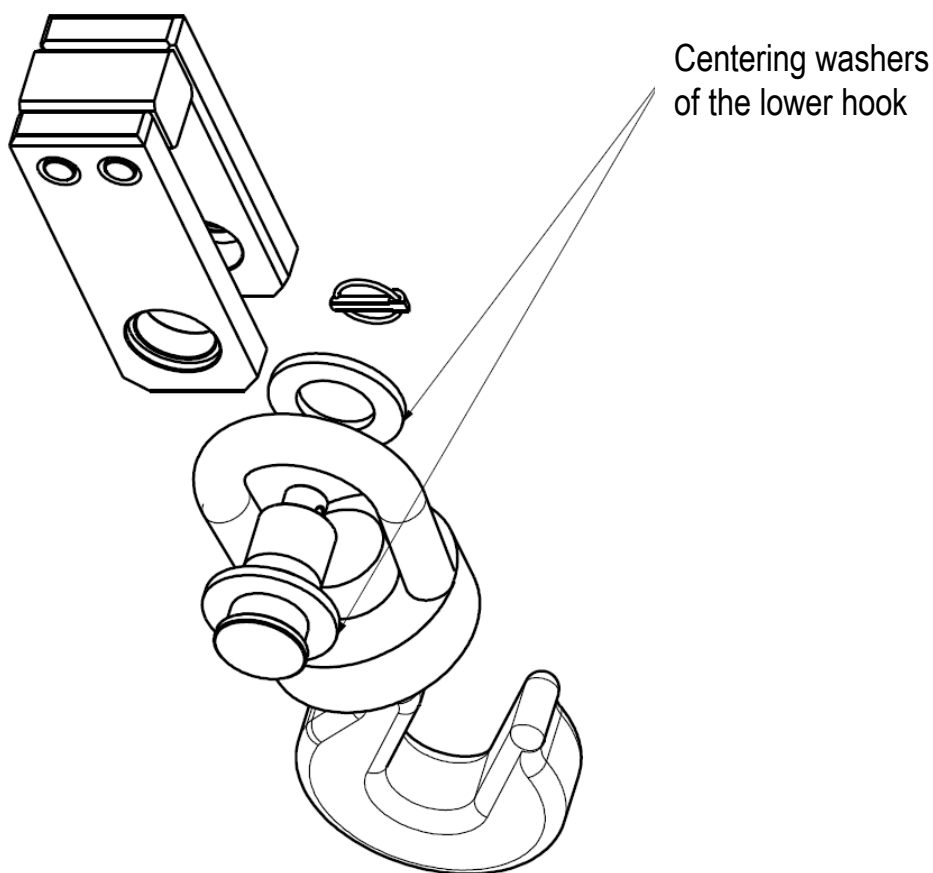

- Insert the locking pins of the upper and lower pivot and check if they are properly locked.
- Once all the accessories of the system are installed, check their integrity and proper installation.
- Do not forget to check the suitability of the crane hook where the crane scale is installed.
- Connect the system to the crane safety hook, ensuring that the ring rests on the saddle of the crane hook and that the lever is positioned safely.
- Once the load harnessing is finished, walk away and lift the the crane scale a few centimetres off the floor.
- The crane scale is supplied with batteries already installed. Then by pressing the **C** button on the front panel, the electronic crane scale can be switched on and used immediately.

## 3.2 MAINTENANCE AND VERIFICATIONS

The electronic crane scale and all lifting accessories must be regularly maintained.

For the prevention of accidents or damages, it is necessary that the maintenance is done according to the manufacturer's instructions. Maintenance must be performed only by persons who have acquired the necessary technical expertise.

To ensure a safe operation, follow these instructions:

- carry out a continuous regular maintenance and cleaning.
- entrust the maintenance and repair operations only to trained and authorized personnel or to the Dini Argeo service dept.
- use only original spare parts.
- do not use the electronic crane scale where there is non-compliance with the safety checklist.
- any maintenance, repair or cleaning should be done with the electronic crane scale turned off.

### 3.2.1 DAILY MONITORING

Each time the operator starts a new work cycle with the electronic crane scale, one must:

- check all instrument parts;
- carry out a general visual inspection of the whole system;
- monitor the integrity and efficiency of all the component parts of the system as the safety lever hooks, swivel hook, pins and locking pins, rings etc..

### 3.2.2 REGULAR MAINTENANCE

Maintenance should be carried out only by persons who have acquired the necessary technical expertise and are specialized and trained for this purpose.

<p><b>Every 3 months or, in any case, after 12.500 weighs</b></p>	<ul style="list-style-type: none"> <li>- Check all dimensions of the parts which make up the instrument;</li> <li>- Check the wear on the handle or the eyelet, by checking if there are any plastic deformations, mechanical damages(irregular), cracks, corrosion, damage to threaded portions and the twists;</li> <li>- Check the tightness of the splice plate on the hook, and the presence of defects, and ensure its proper functioning;</li> <li>- If other metrological and mechanical irregularities are detected, have the electronic crane scale repaired by qualified personnel (authorized service support).</li> </ul> <p>Do not for any reason carry out the repair by yourself. In case of non-compliance turn immediately off the electronic crane scale.</p> <p>All repair operations and the parts used are classified and stored in the maintenance register.</p>
<p><b>Every 12 months or, in any case, after 50.000 weighs</b></p>	<p>The extraordinary maintenance of the product should be made by specialized personnel</p>



It is of utmost importance that all the maintenance and repair operations, and the used pieces are recorded and filed in the appropriate produce maintenance registry.

For further information on regular checks, see the following table:

COMPONENT	PART	CONTROL	LIMIT	REMEDY	SOLUTION
<b>Shackle</b>	Locking bolts	<ul style="list-style-type: none"> <li>Loosening</li> </ul>		Tightening	<p>In order to replace the damaged parts, contact personally the manufacturer.</p> <p>In case of replacement of the original parts, use only original spare parts.</p>
	Pivot	<ul style="list-style-type: none"> <li>Deformation</li> </ul>			
	Shackle surface	<ul style="list-style-type: none"> <li>Wear</li> <li>Deformation</li> </ul>			
	Split pin	<ul style="list-style-type: none"> <li>Positioning</li> </ul>		Full insertion of the split pin in the pivot	
<b>Hook</b>	Eyelet and hook surfaces	<ul style="list-style-type: none"> <li>Mechanical damages</li> </ul>			
	Eyelet and hook	<ul style="list-style-type: none"> <li>Wear</li> <li>Corrosion</li> </ul>	Current size > 95% compared to the initial sizes		
	Eyelet	<ul style="list-style-type: none"> <li>Orientation of the eyelet</li> </ul>	Can not be torque		
	Hook opening	<ul style="list-style-type: none"> <li>Deformation</li> </ul>	Deformation > 10% of the original sizes		
	Squint Hook	<ul style="list-style-type: none"> <li>Tension</li> </ul>	Tension > 10°		
	Safety Splice plate	<ul style="list-style-type: none"> <li>Damages</li> </ul>			
<b>Instrument</b>	Locking screws	<ul style="list-style-type: none"> <li>Loosening</li> </ul>		Tightening	

### 3.2.3 MAINTENANCE REGISTRY

In order to cope with problems like the wear of the mechanic and electronic components, and the grip load devices, it is necessary that one carries out a regular and systematic maintenance.

The maintenance and respective time intervals must take place according to the indications of the manufacturer shown in the instructions manual of the instrument.

The maintenance interventions must be made only by specialised and qualified personnel.

The maintenance person must have attended training courses and must know the safety norms in the use of crane scales and concretely apply them.

In this booklet the user must document in chronological order all the maintenance interventions carried out on the crane scale (inspection/control, revision, repair), as well as any fact or particular event which might have influenced safety matters.

In the following pages of this booklet there is a “maintenance registry” in which all ordinary and extraordinary maintenance interventions on your instrument, should be reported.

All information is very important and can invalidate the validity of the warranty in the case that it's not reported in detail and accurately. It is also advisable to make sure that:

- the internal responsible person carries out the quarterly verification and regularly records it on this booklet;
- the authorised personnel stamps the appropriate box at the end of each annual maintenance intervention.

### 3.2.4 CLEAN

If the electronic crane scale is often used in different places, especially in places with the presence of dust and moisture, it is necessary to have the instrument regularly cleaned.

Clean the keyboard of electronic crane scale with a soft damp cloth with a detergent or a mild detergent solution.



Do not use any type of solvent or industrial chemical product while cleaning the instrument and all the system parts.

### 3.2.5 REPLACING THE REMOTE CONTROL BATTERIES

As mentioned above, the MCWHU electronic crane scale is supplied with a remote control that duplicates the functions of the keyboard. When using the remote control, the battery may die and must be replaced.

To replace the batteries in the remote control, carry out the following steps:

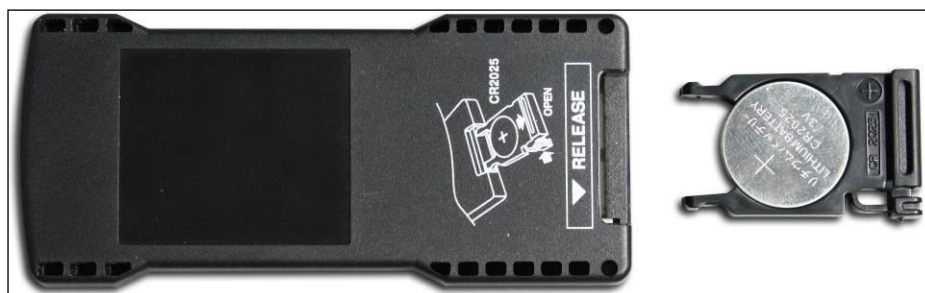

- take out the battery box placed on the back of the remote control;
- replace the old battery with a new one and make sure that it's correctly inserted;
- reinsert the box with the new battery in the remote control.



### 3.2.6 THE BATTERY RECHARGE BY OPTIONAL KIT

If it is necessary to constantly use the MCWHU crane scale, it is possible to request a kit including a spare battery pack and a charger adapter.

To perform a battery change and development its functions, perform the following steps:

- 1) Screw off the socket head screws placed on the battery pack (behind the machine).

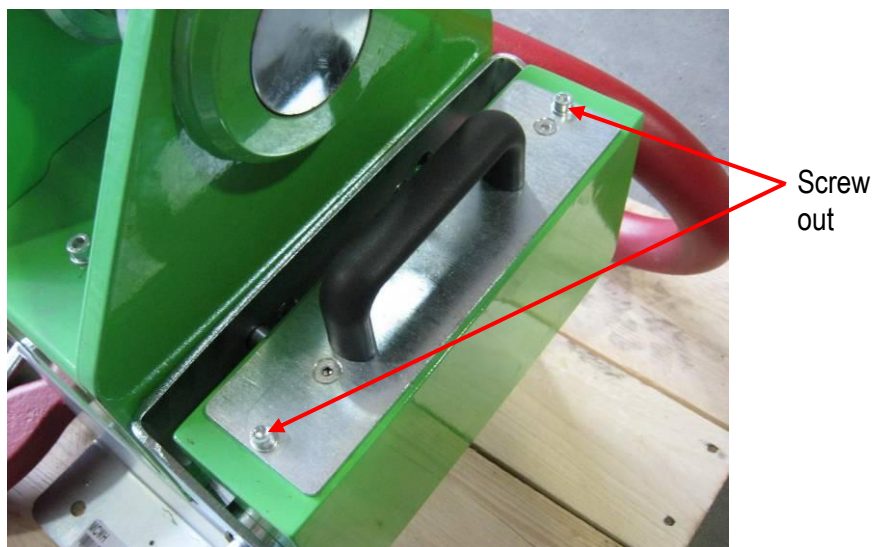

- 2) Slowly remove the battery pack.
- 3) The battery pack is internally connected to the electronic card of the instrument through an AMP automotive connector.

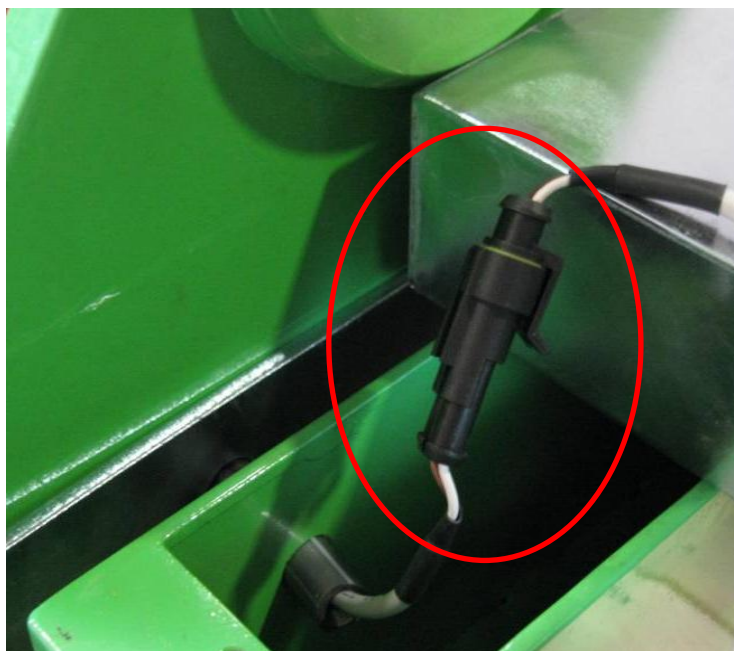

- 4) Unplug the AMP automotive connector from the battery pack.

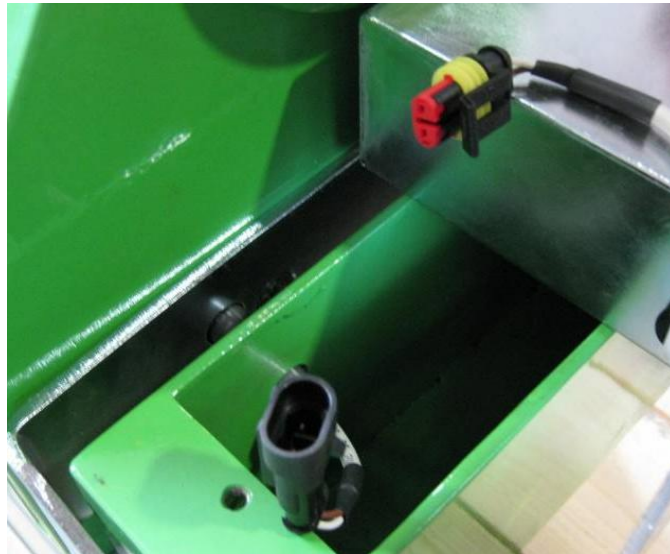

- 5) Connect the charger to the battery pack through the AMP automotive connector.

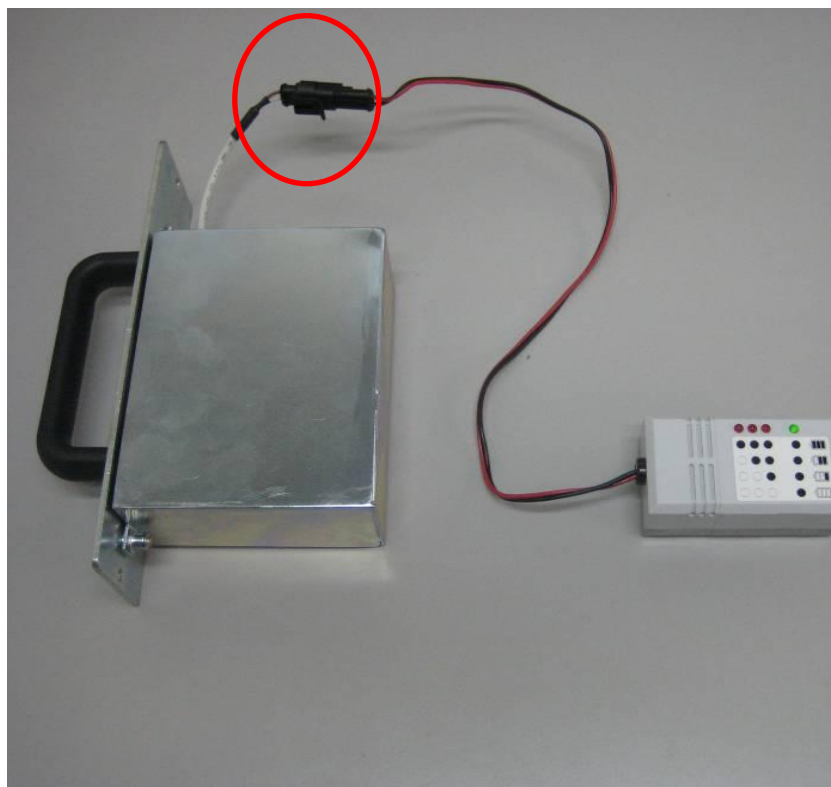

- 6) Insert the power supply (12Vdc) to the power outlet at 230Vac and connect it to the charger through the jack.

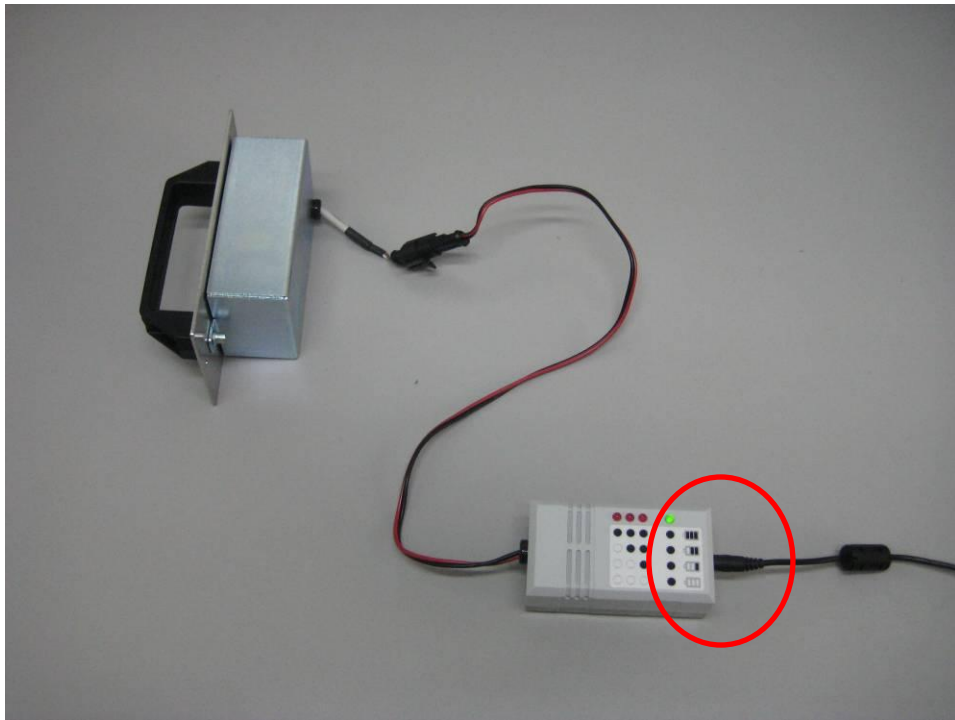

Once the battery is charging, it is possible to connect the spare battery pack to the crane scale.



The charging of the battery pack must only be carried out using the power supply (12Vdc) supplied with the instrument.

**PHASE OF THE BATTERY RECHARGE BY CHARGER ADAPTER**

The charger’s led indicate the charge level reached:

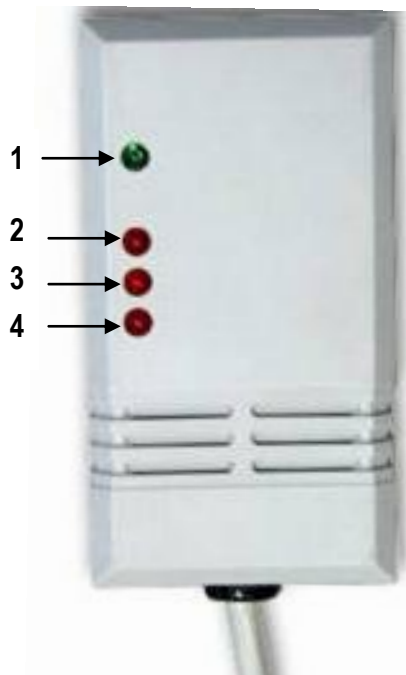

LED	DESCRIPTION
1	When lit, it indicates the presence of voltage.
2	When lit, it indicates the presence of the battery; it means that the battery is connected correctly to the charger.
3	When lit, it indicates that the battery is half charged .
4	When lit, it indicates that the battery is fully charged.

Once the full charge reached:

- Disconnect the power supply charger.
- Disconnect the battery charger.

### 3.3 DECOMMISSIONING AND DISPOSAL

Each consumer should help protect the environment by reducing pollution risks and adopting a responsible attitude, according to the recycling norms in force in the country where the instrument is used.

The symbol of the crossed garbage on the product indicates that, at the end of its useful life, the product must be given to appropriate centres for collection or returned to the distributor when purchasing a new equivalent product.

A proper collection for recycling the product will prevent any negative effects on the environment and health and encourage the recycling of materials.

Therefore, before disposing the product, it is necessary to separate the components of the instrument in each recycling category and place them in the appropriate collection centres.



The unlawful disposal of the product by the user causes the application of the administrative sanctions foreseen by the law.

## 4 WARRANTY

The two years warranty period begins on the day the instrument is delivered. It includes spare parts and labour repair at no charge if the instrument is returned prepaid to the dealer's place of business. Warranty covers all defects not attributable to the Customer (such as improper use) and not caused during transport.

If on site service is requested (or necessary), for any reason, where the instrument is used, the Customer will pay for all of the service technician's costs: travel time and expenses plus room and board (if any).

the Customer pays for the transport costs (both ways), if the instrument is shipped to dealer or manufacturer for repair.

The warranty is voided in the event that the instrument is returned or if there are damages caused by: inobservance of indications in the manual, interventions by non authorised personnel, and/or non original spare parts, user incapacity and/or improper use, incorrect maintenance, loss or impossibility of presenting the maintenance booklet.

This warranty does not provide for any compensation for losses or damages incurred by the Customer due to complete or partial failure of instruments, even during the warranty period.